

MAKE YOUR OWN WORKING PAPER CLOCK

Cut this book
into 160 pieces,
glue them together,
and have your own
paper clock that
actually works

- A precision-engineered timepiece
- It actually works
- It keeps perfect time
- It can be rewound
- It can be regulated
- Operated by weights
- Educational and easy to make
- Complete paper parts for clock contained in this book
- A unique, working conversation piece
- Fun for the entire family
- Amaze your friends

JAMES SMITH RUDOLPH
Preface by **ISAAC ASIMOV**



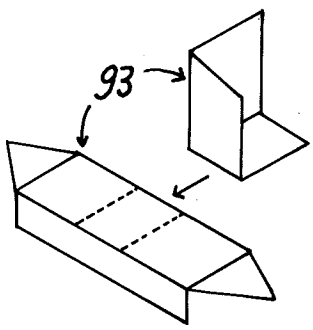

Fig. 10

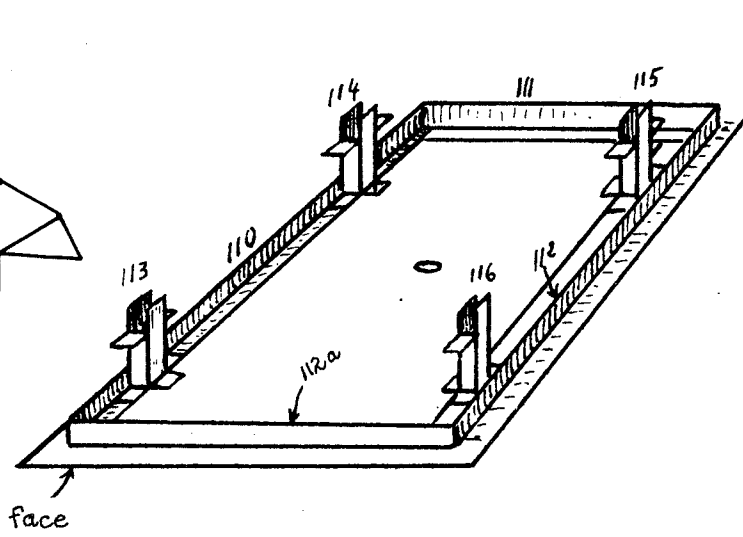

Fig. 15

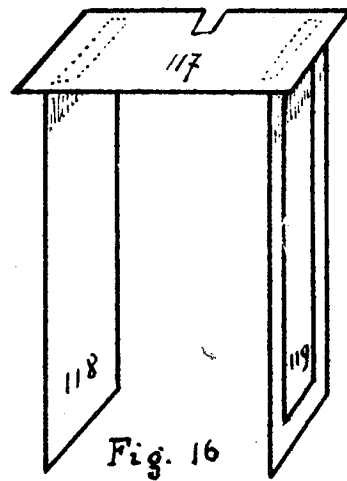

Fig. 16

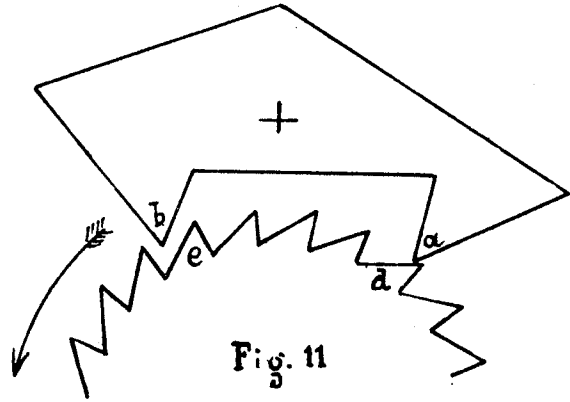

Fig. 11

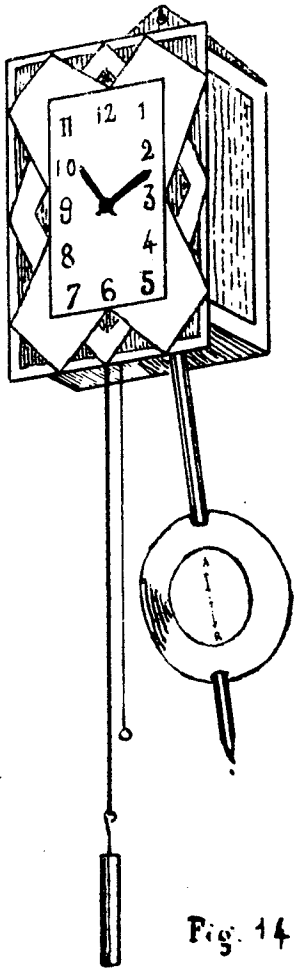

Fig. 14

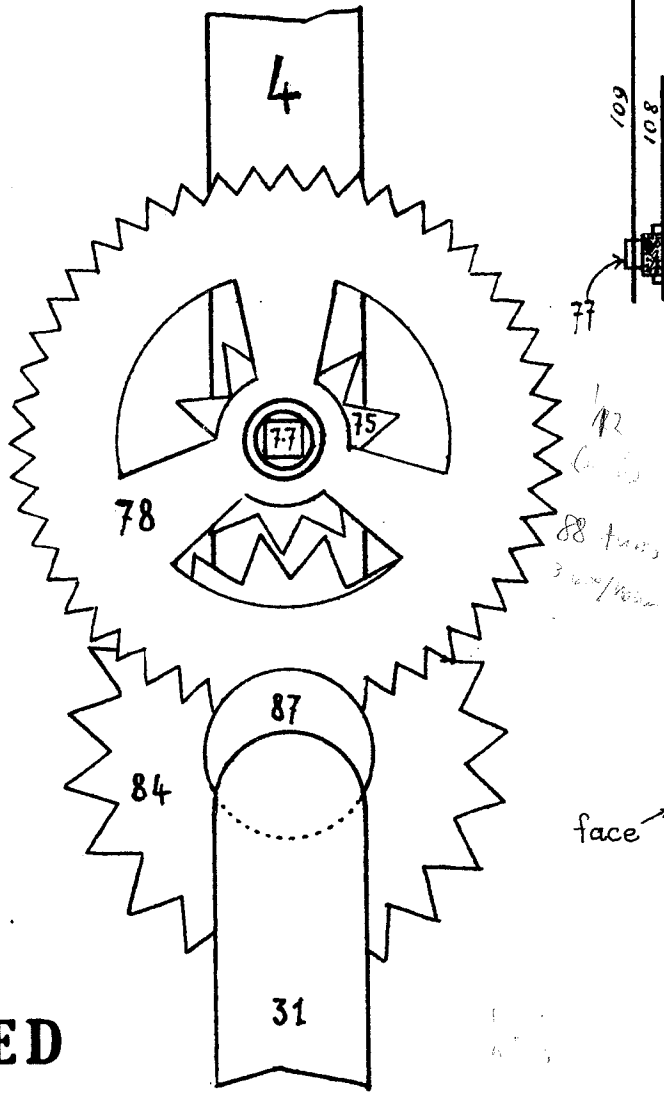

Fig. 12

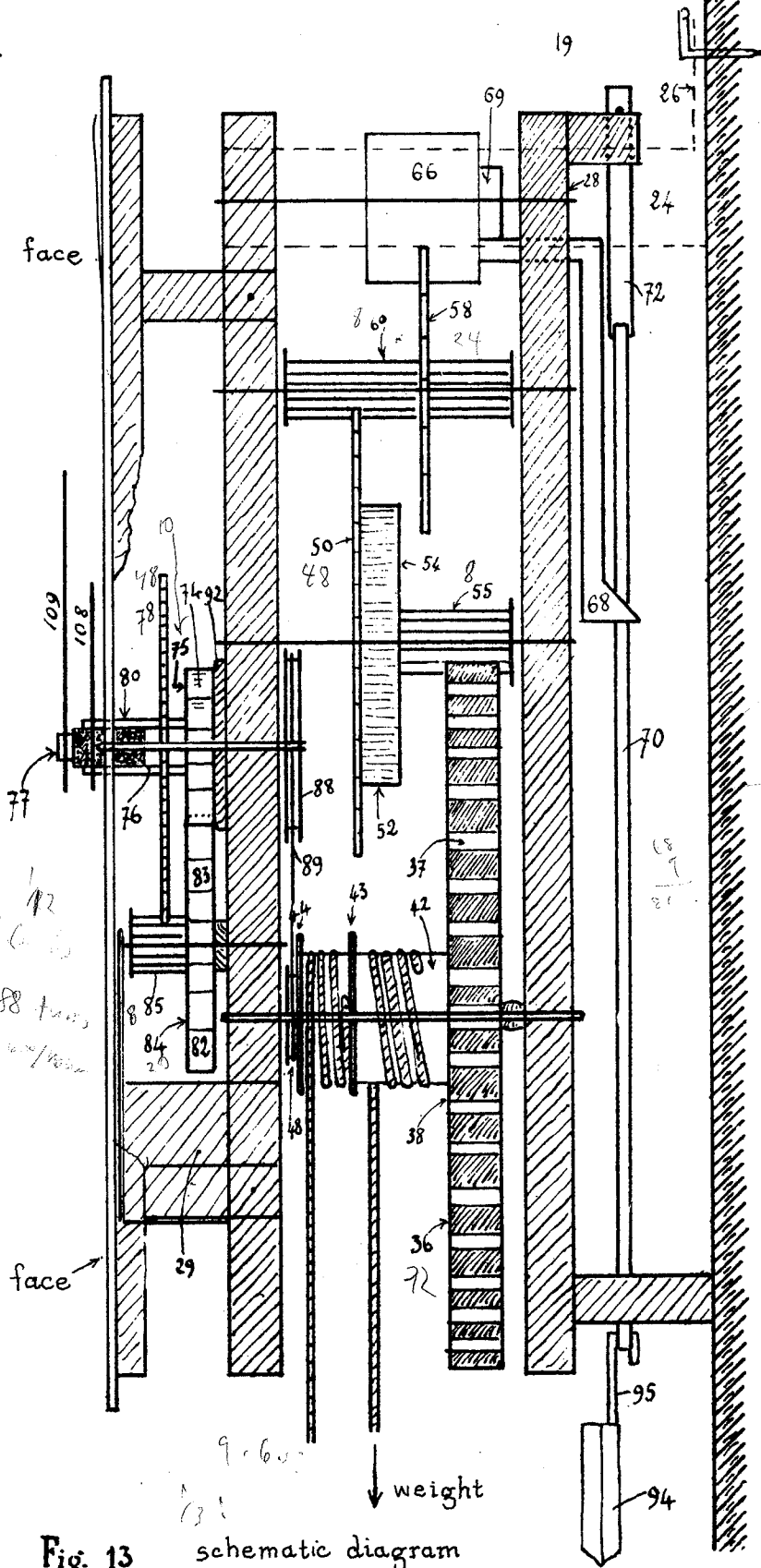

Fig. 13

schematic diagram

ASSEMBLED

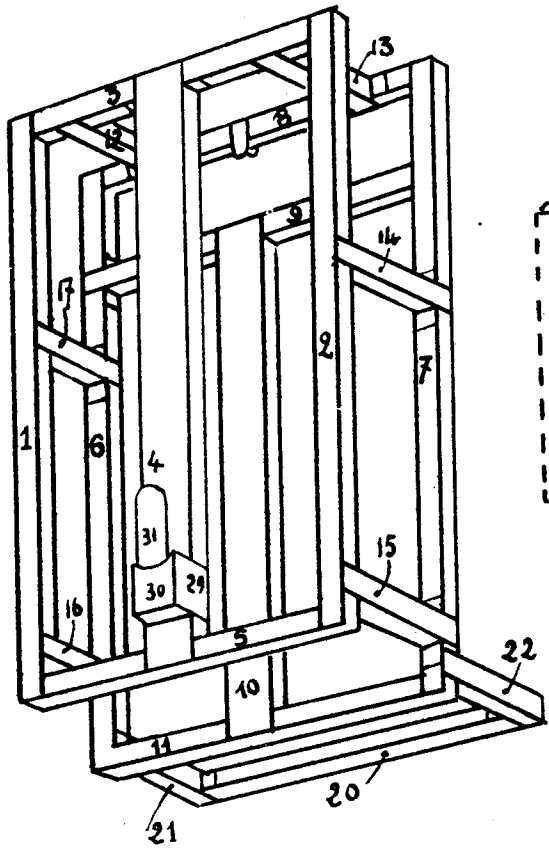

Fig. 1.

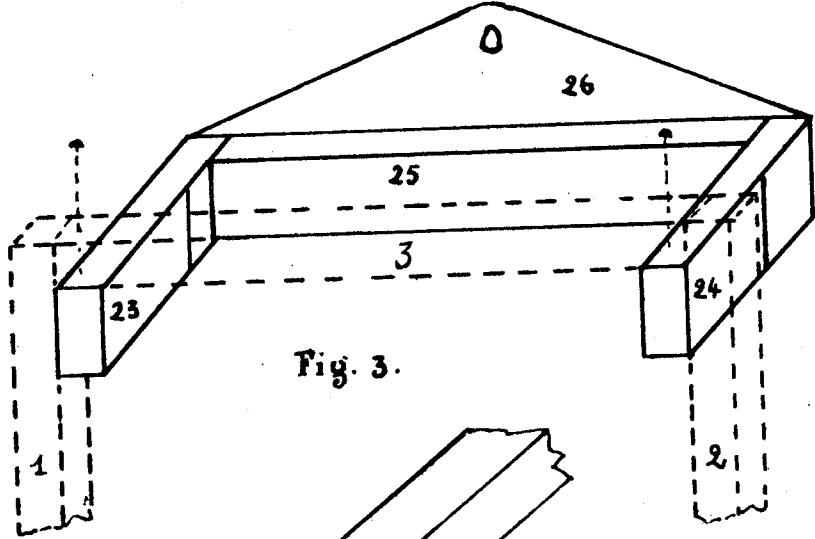

Fig. 3.

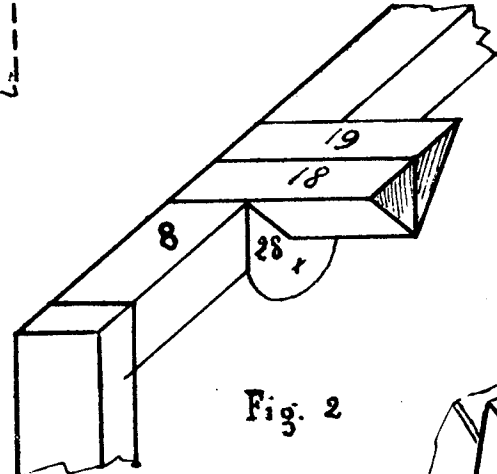

Fig. 2.

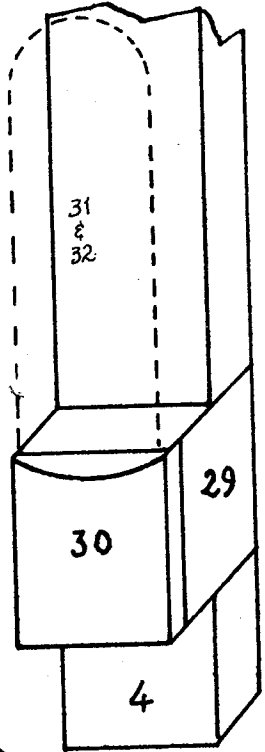

Fig. 4.

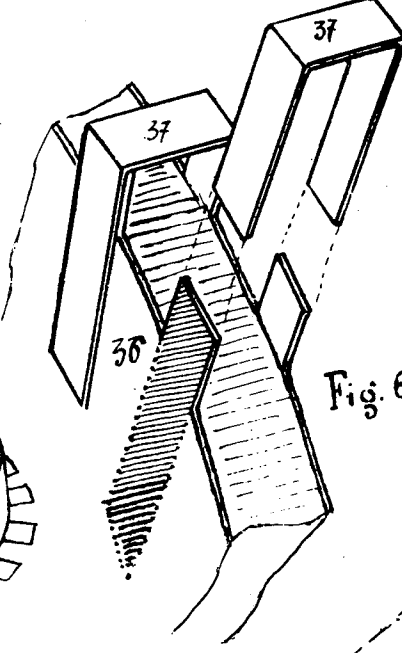

Fig. 6.

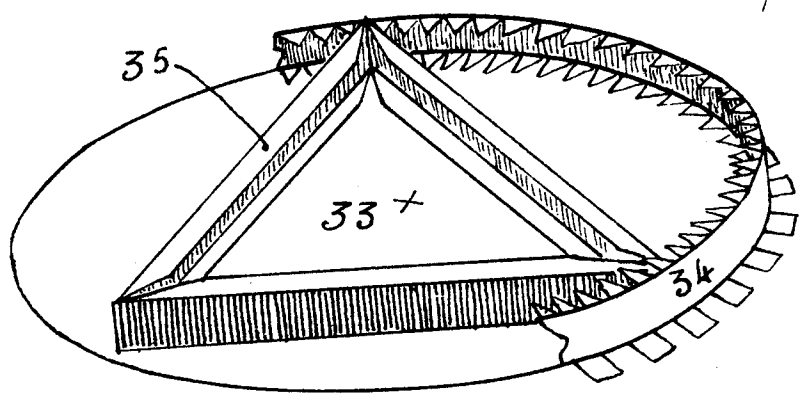

Fig. 5.

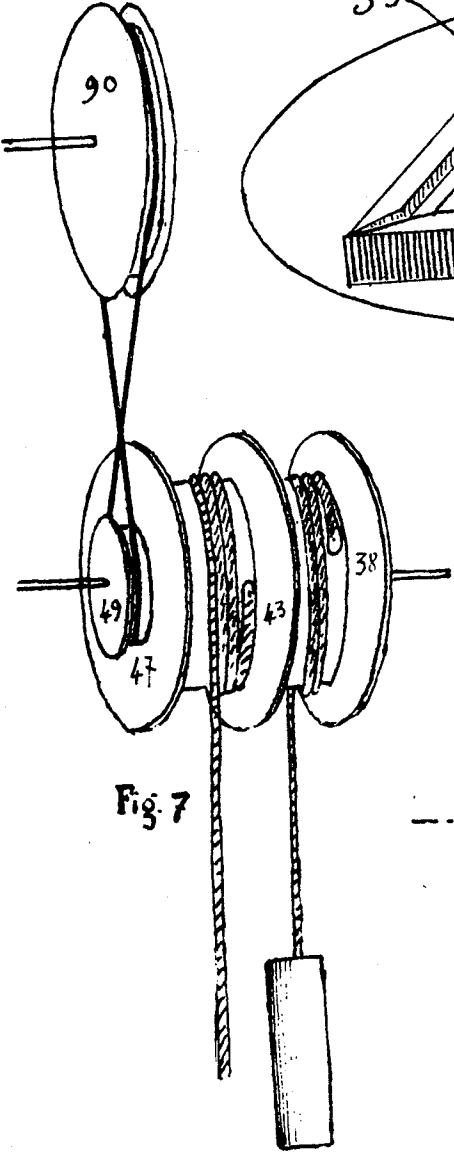

Fig. 7.

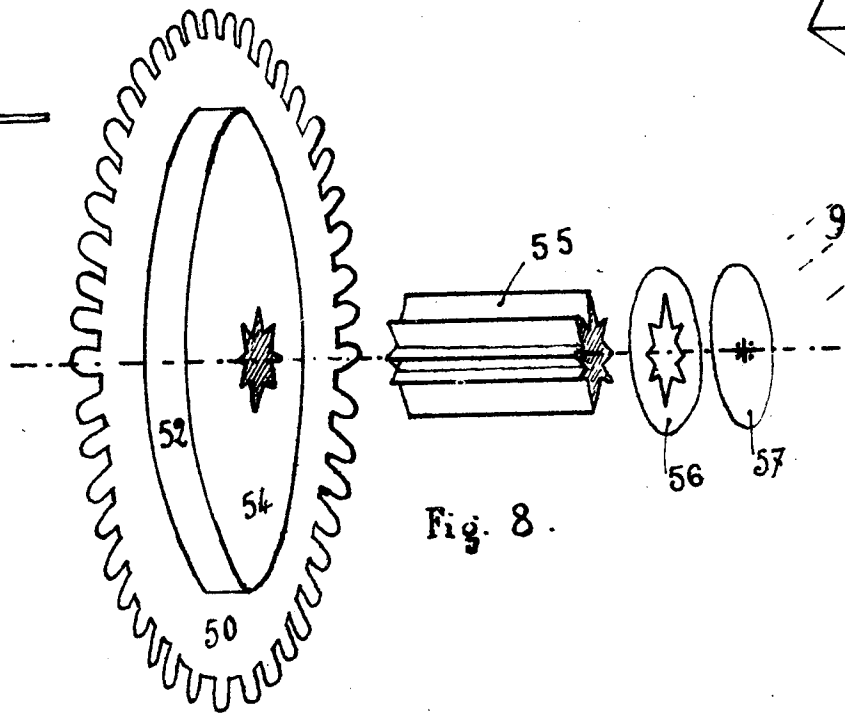

Fig. 8.

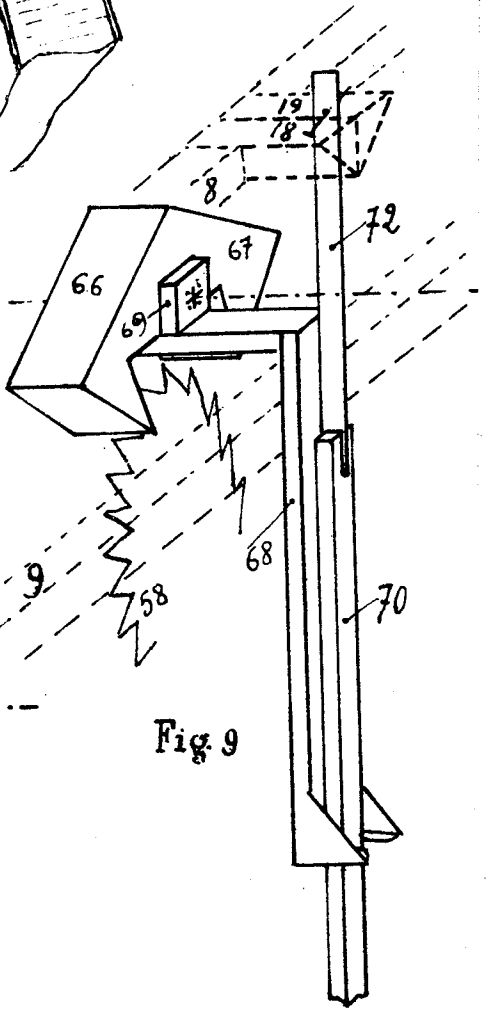
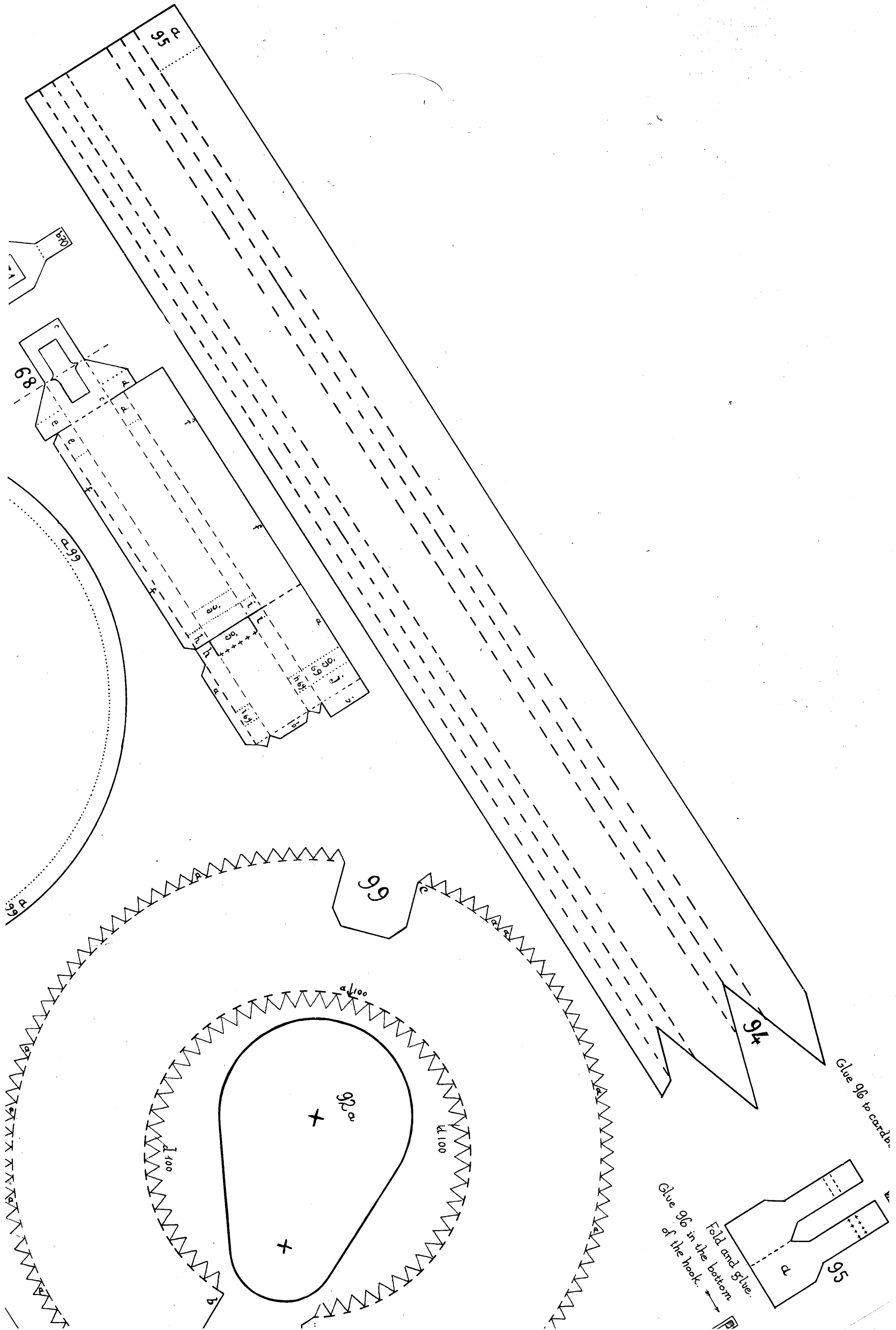
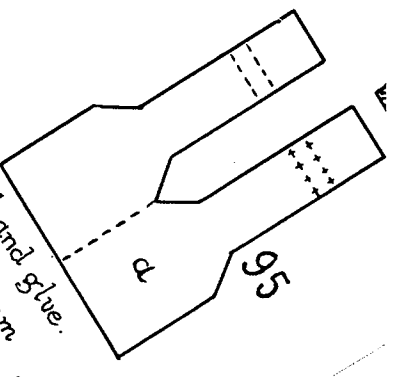

Fig. 9.



Glue 96 to cards.

Fold and glue.
 Glue 96 in the bottom
 of the hook.



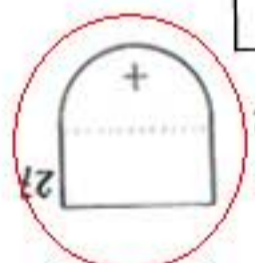
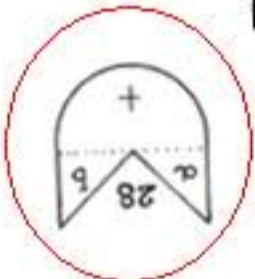
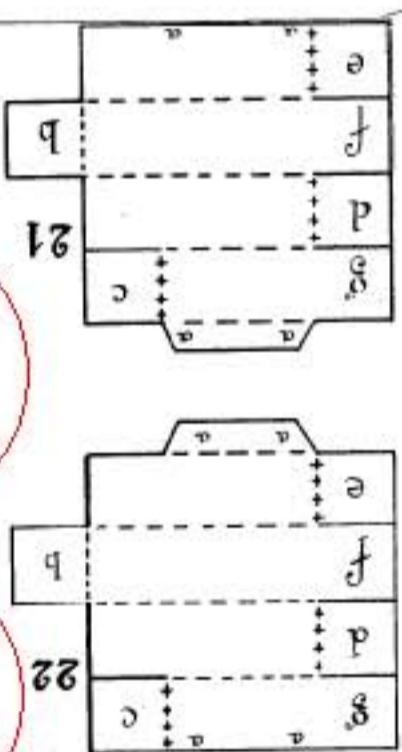
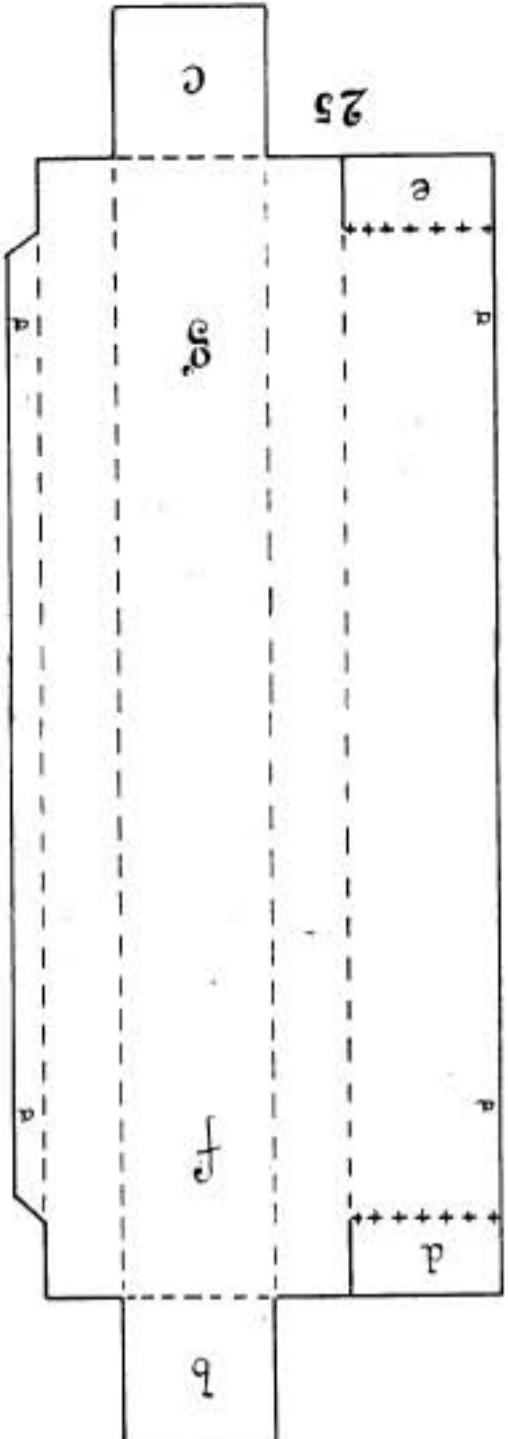
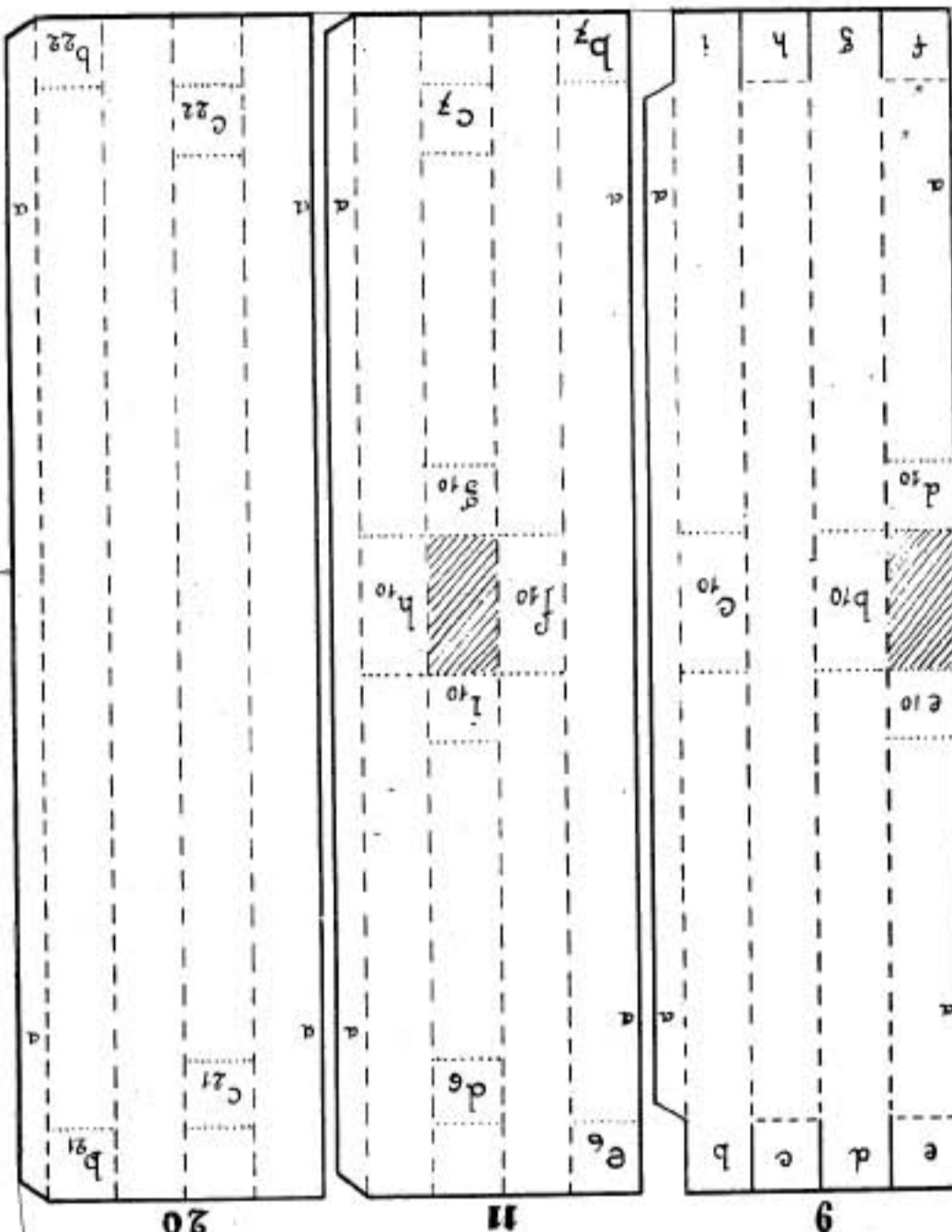
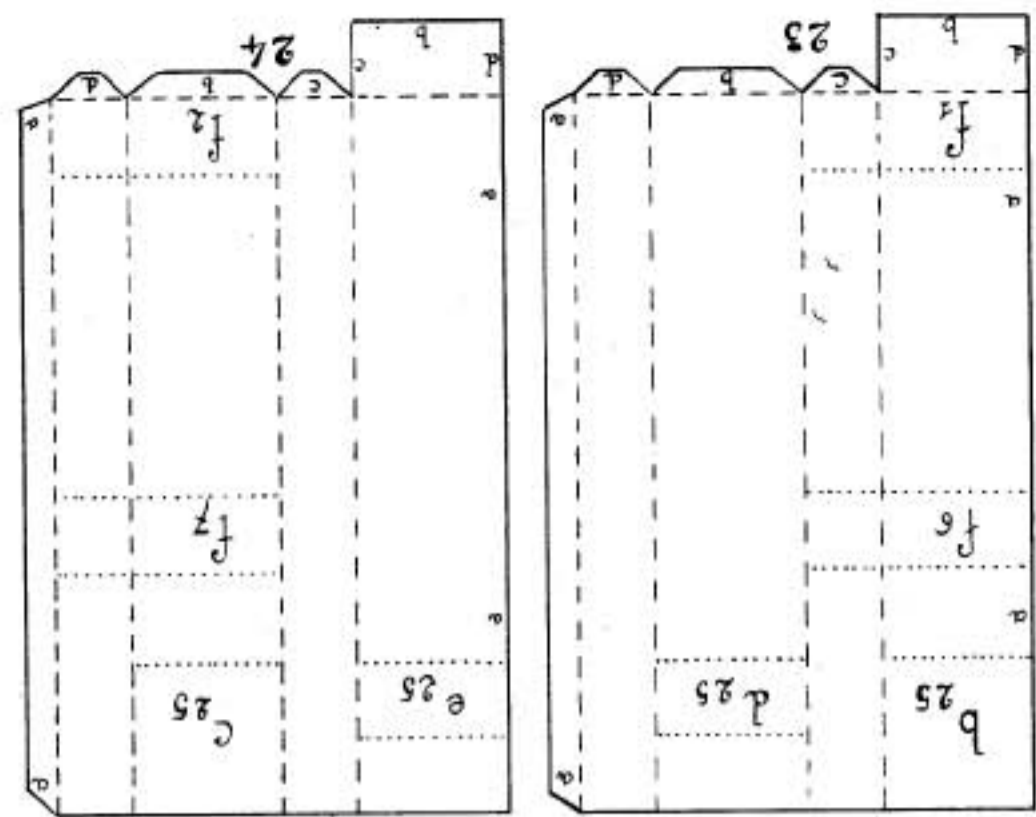

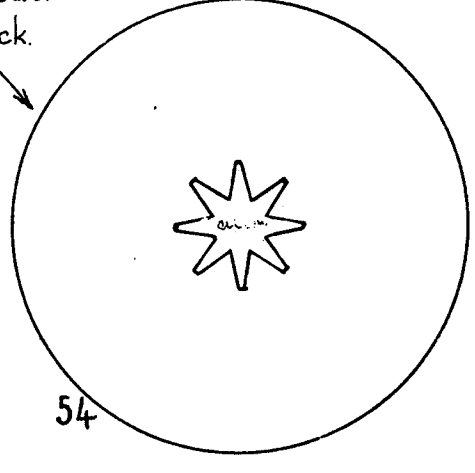
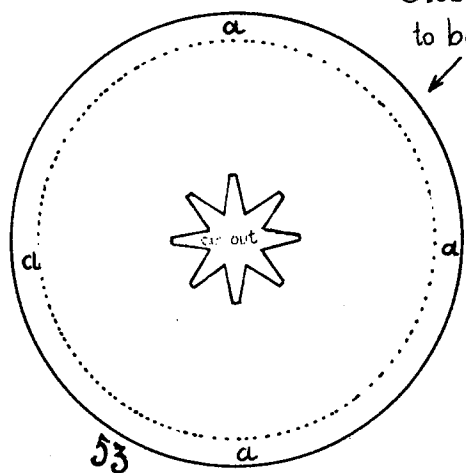
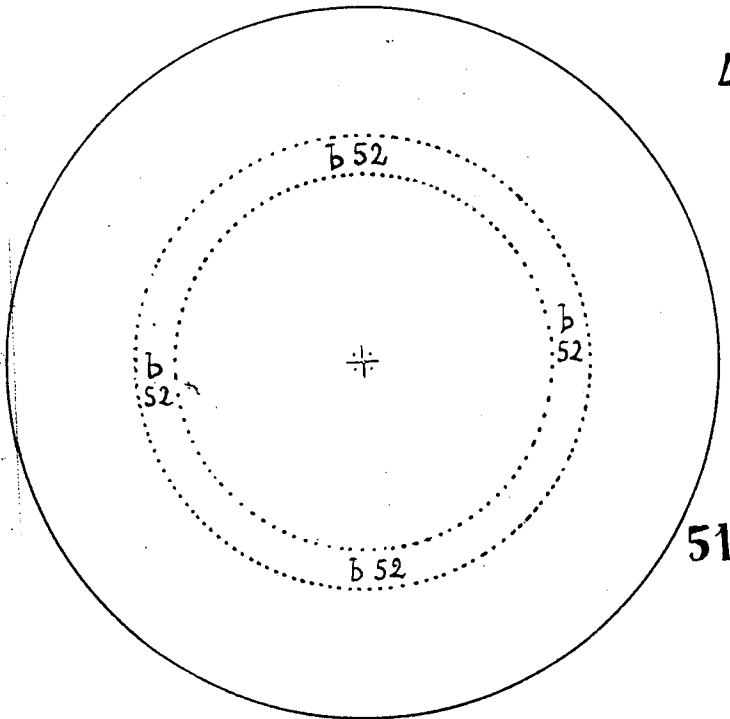
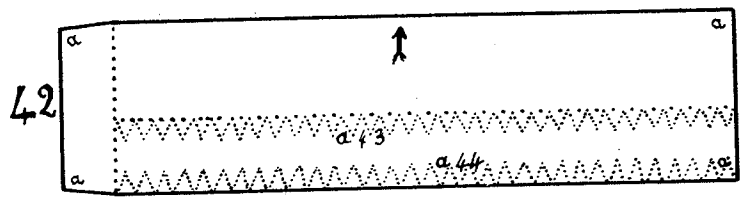
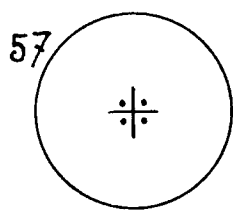
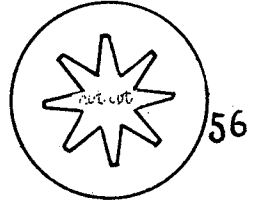
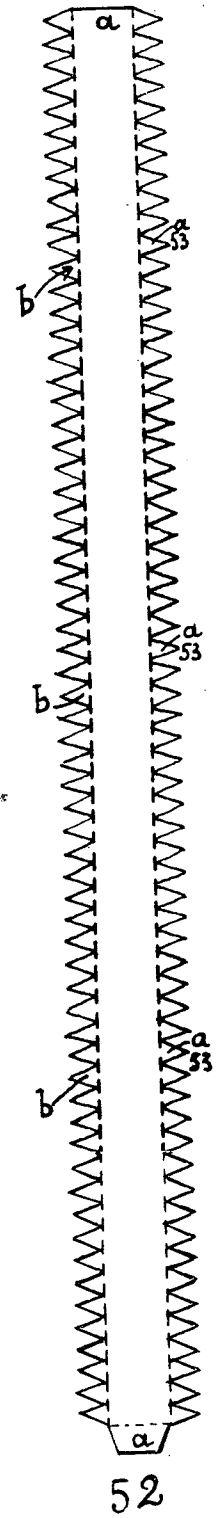
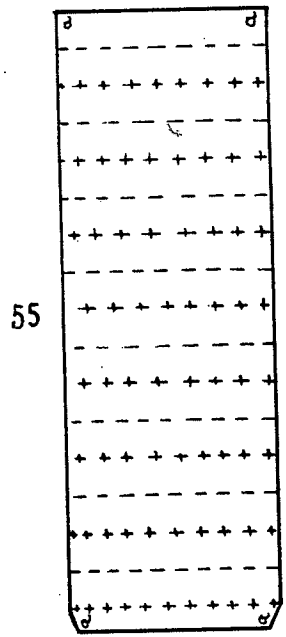
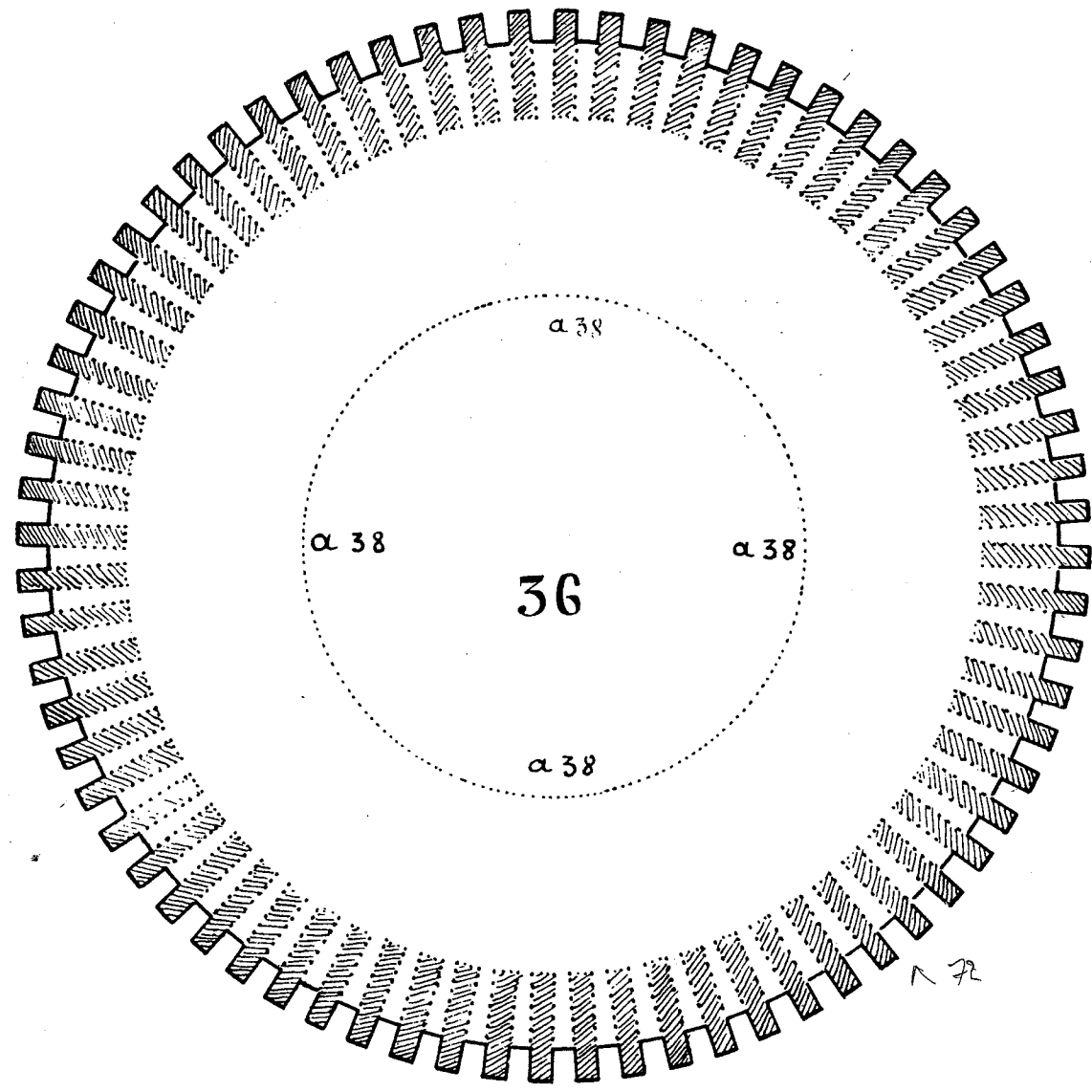
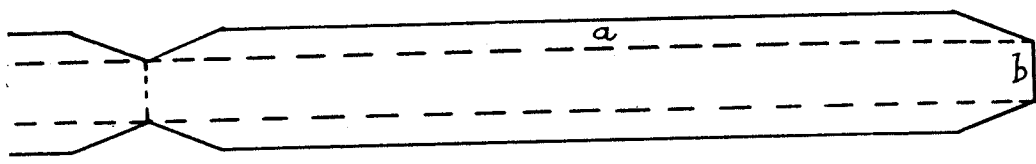
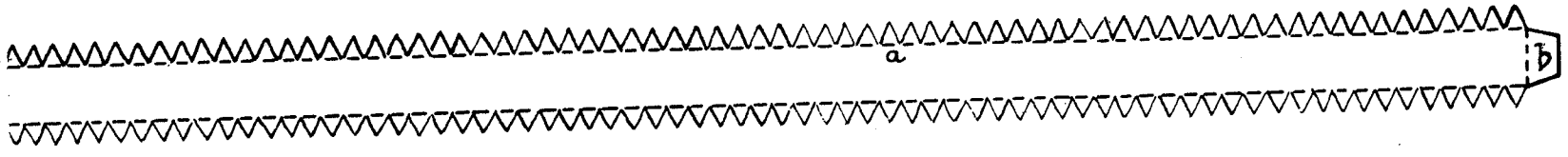

Glue back to back.

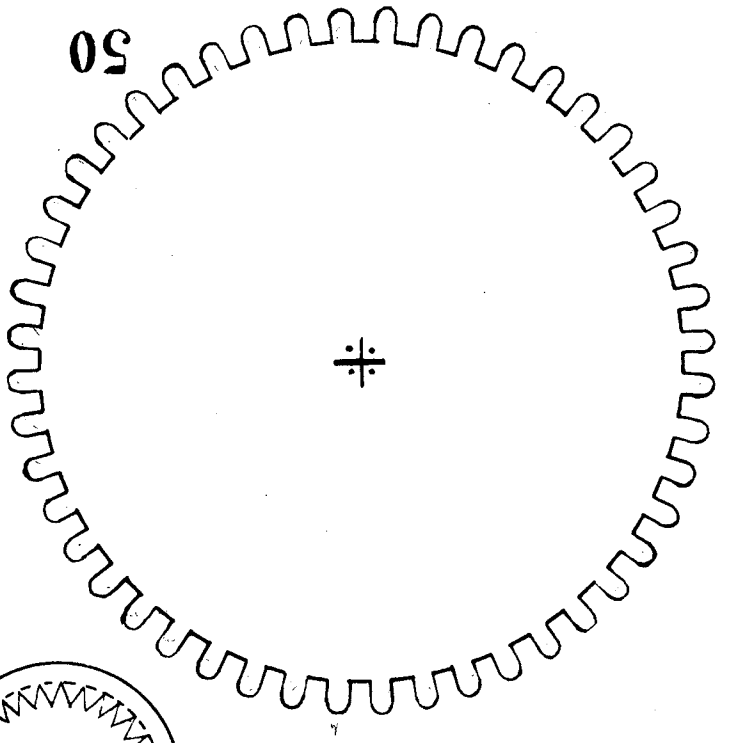
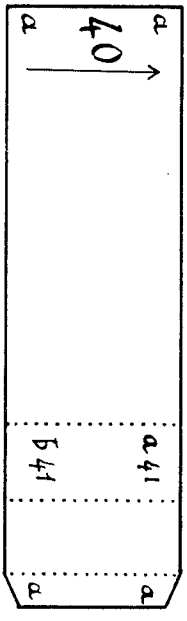
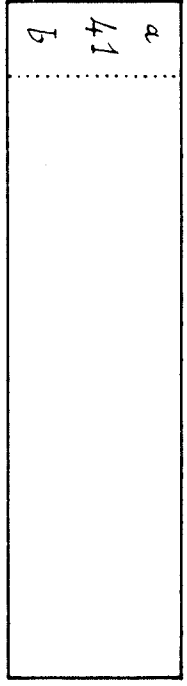
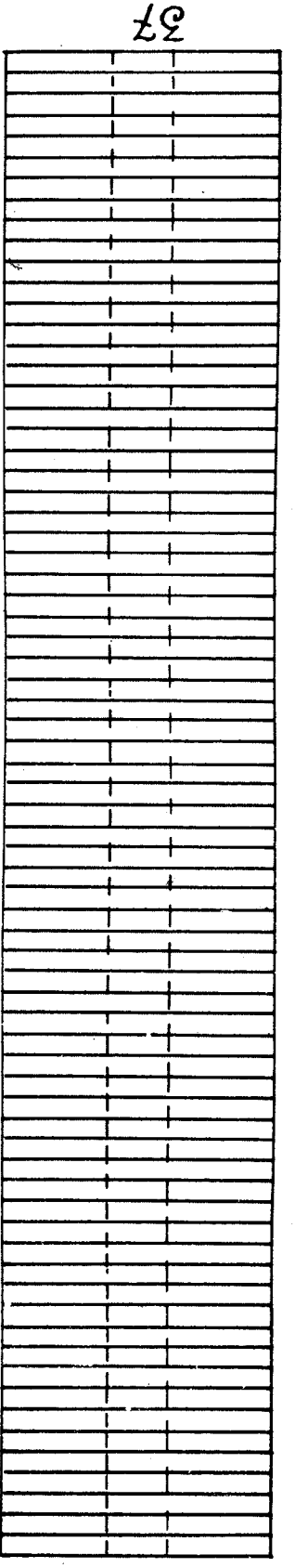

Glue 50 back to back with 51.

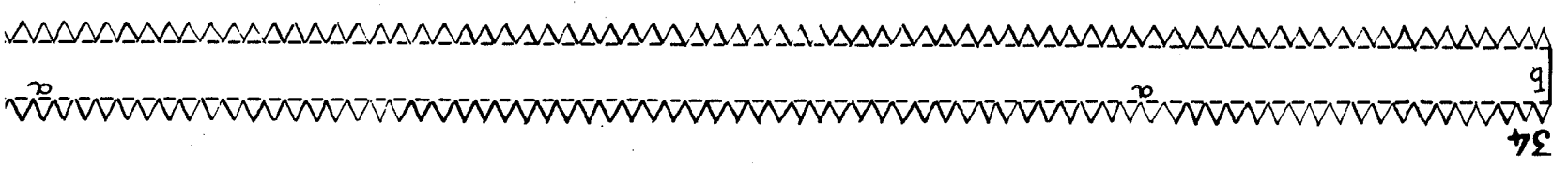
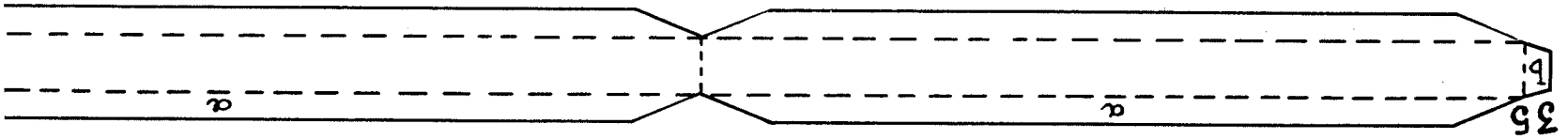
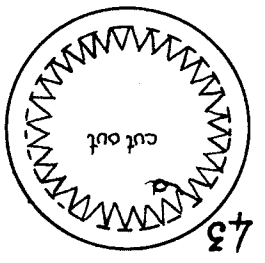
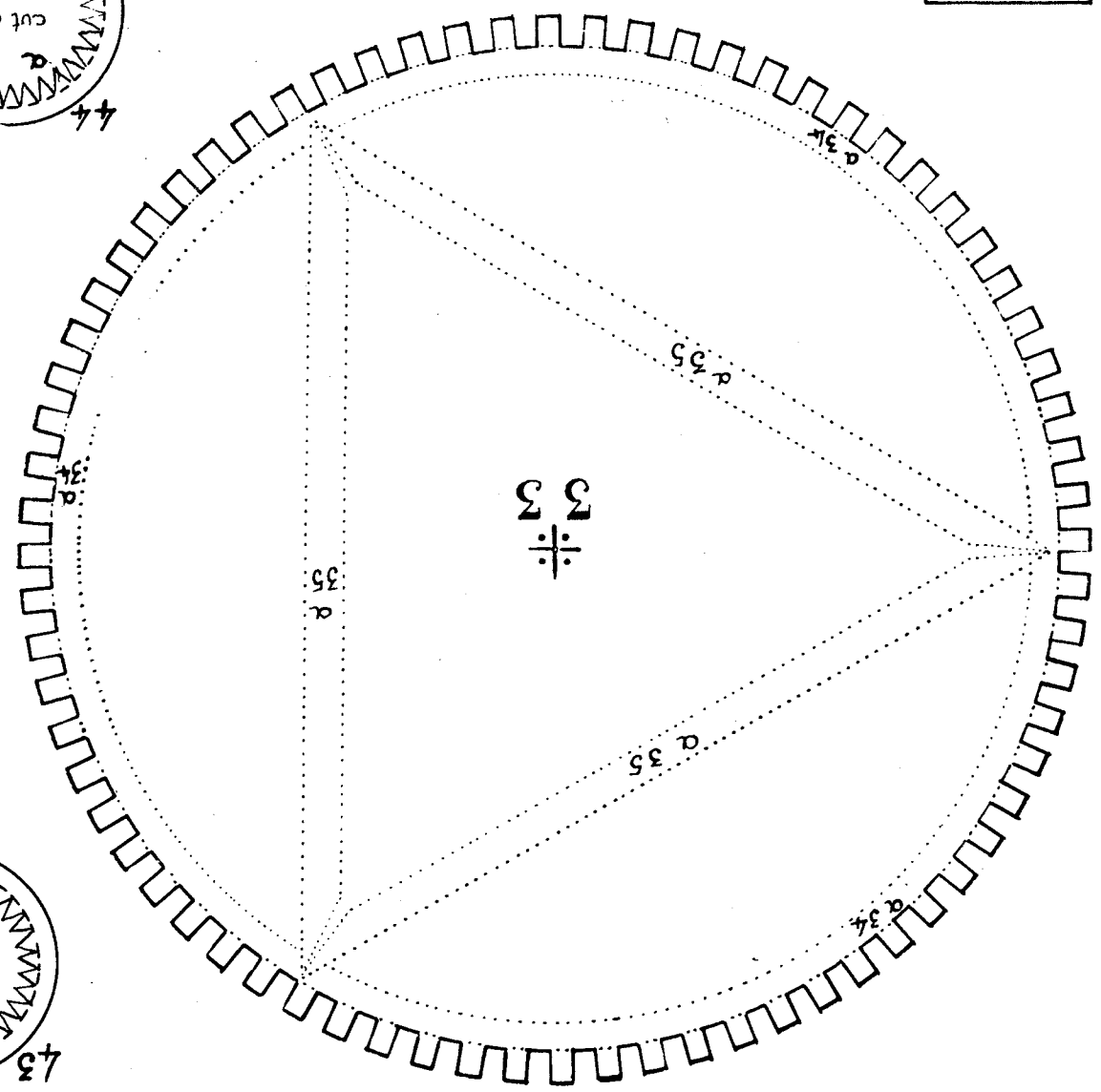
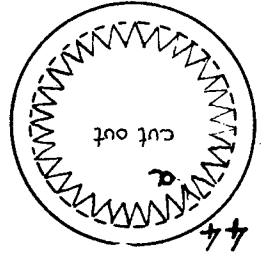

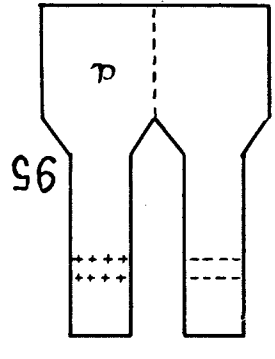
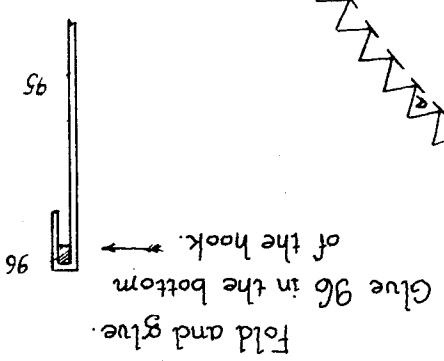
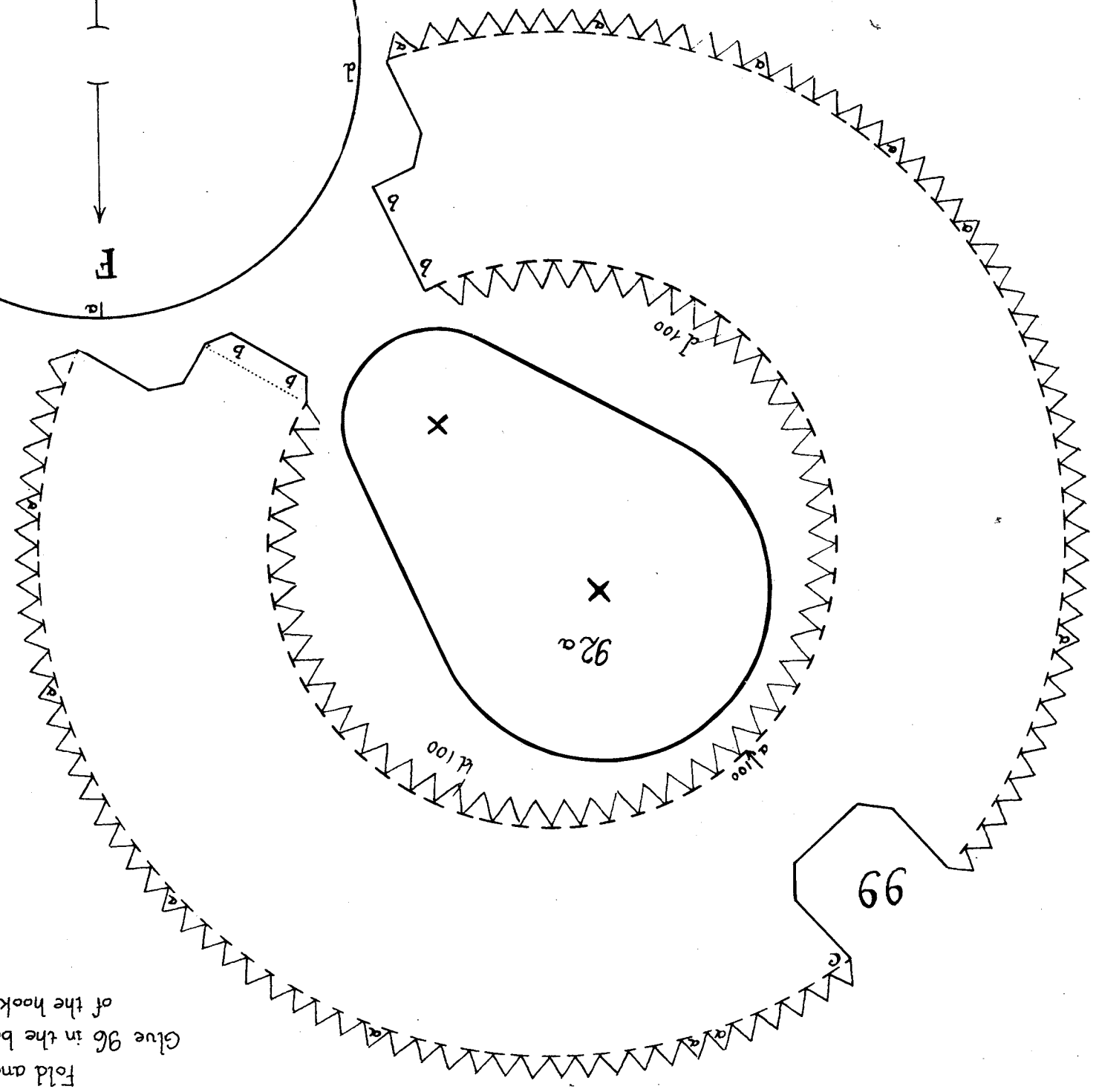
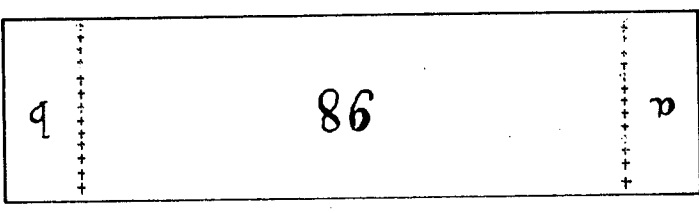
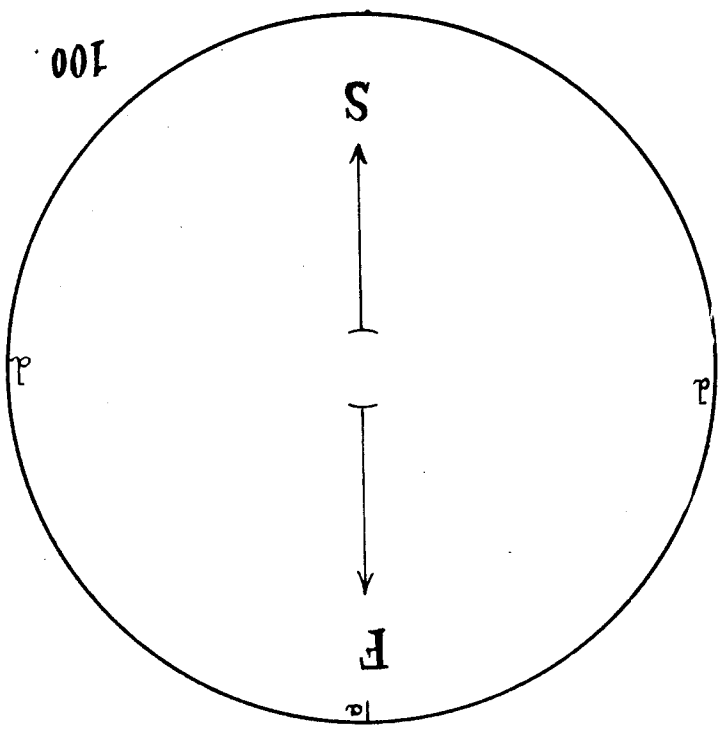

Glue 96 to cardboard 1 mm. thick

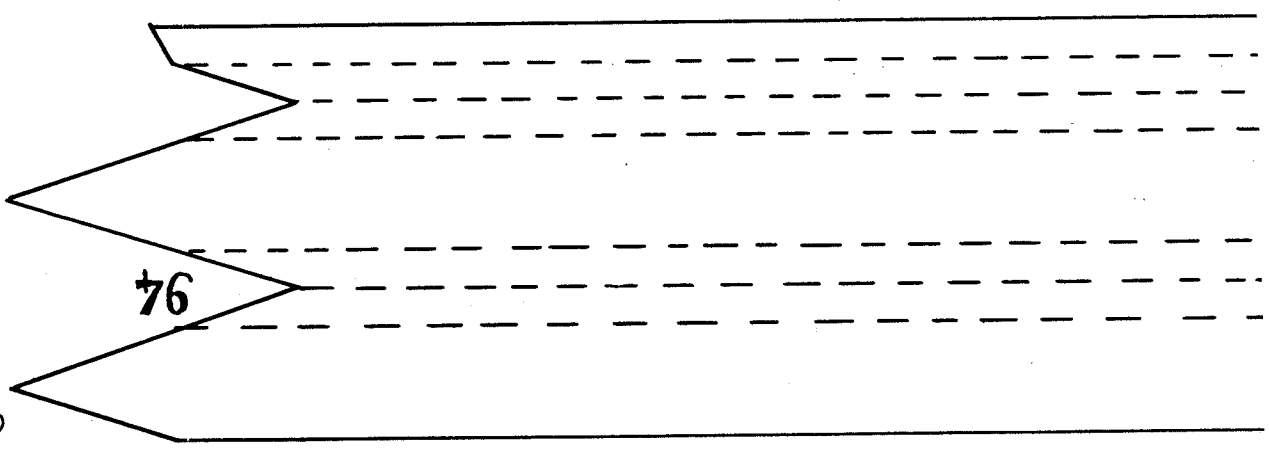

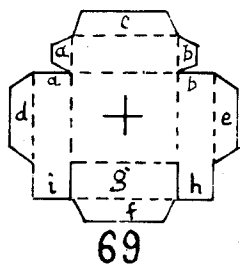
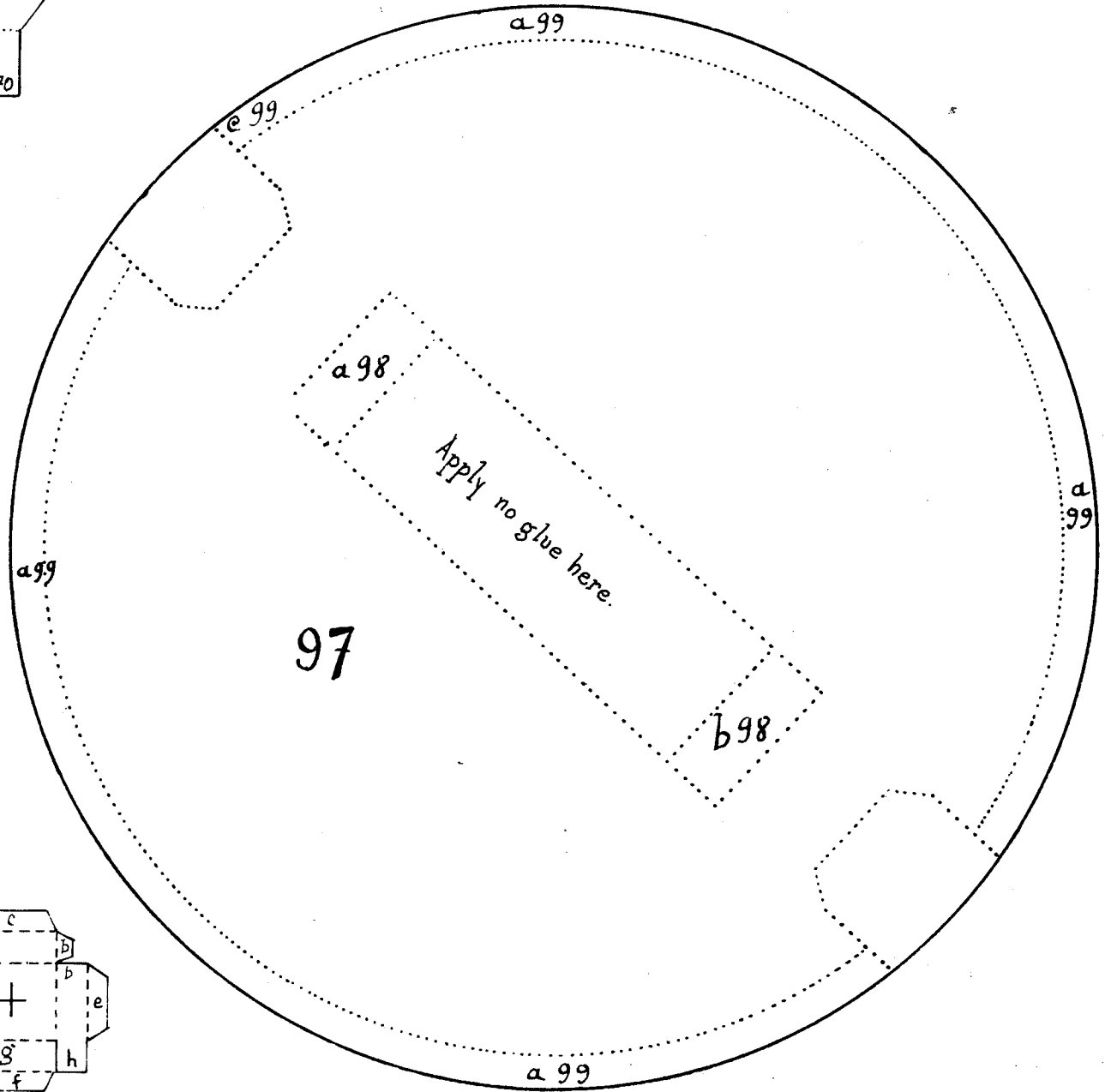
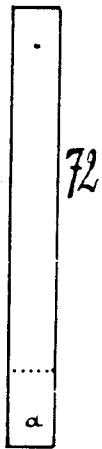
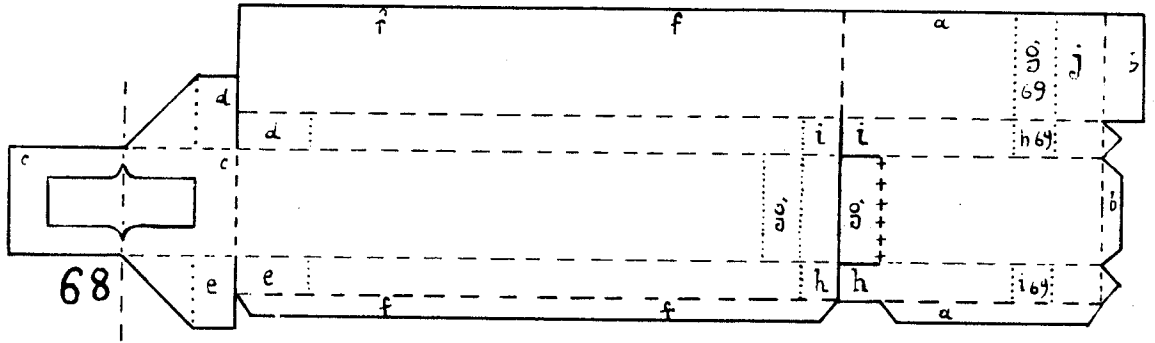
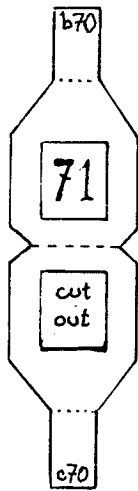
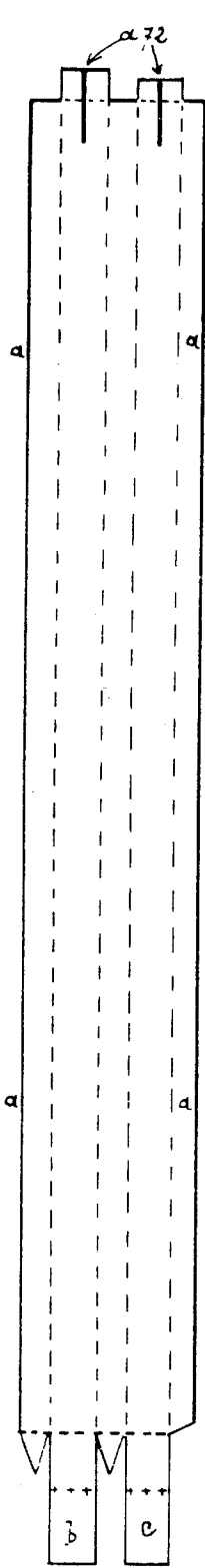
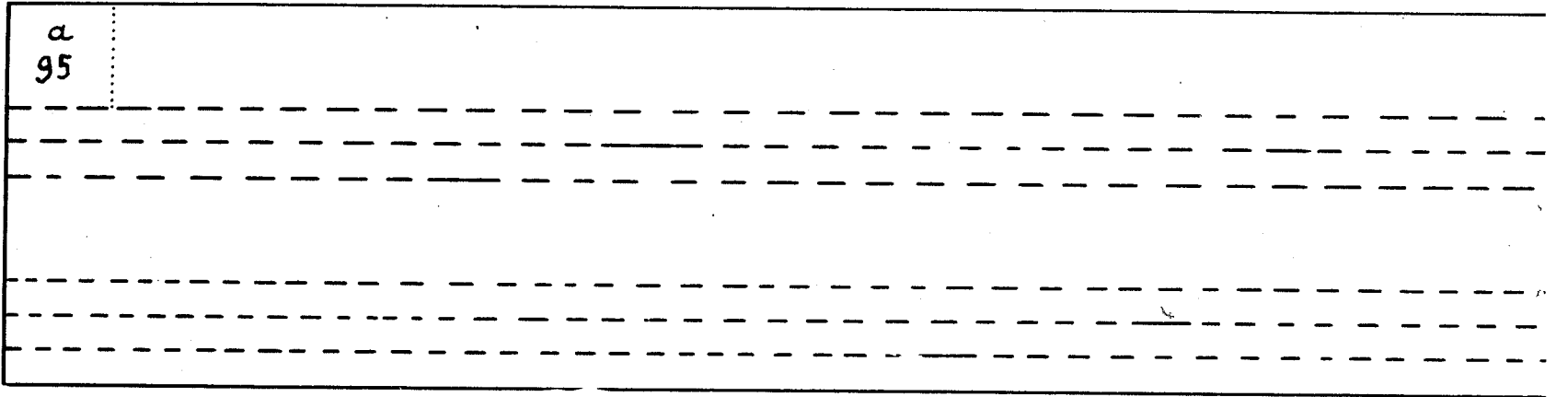

Fold piece 71 and glue between b and c of 70.

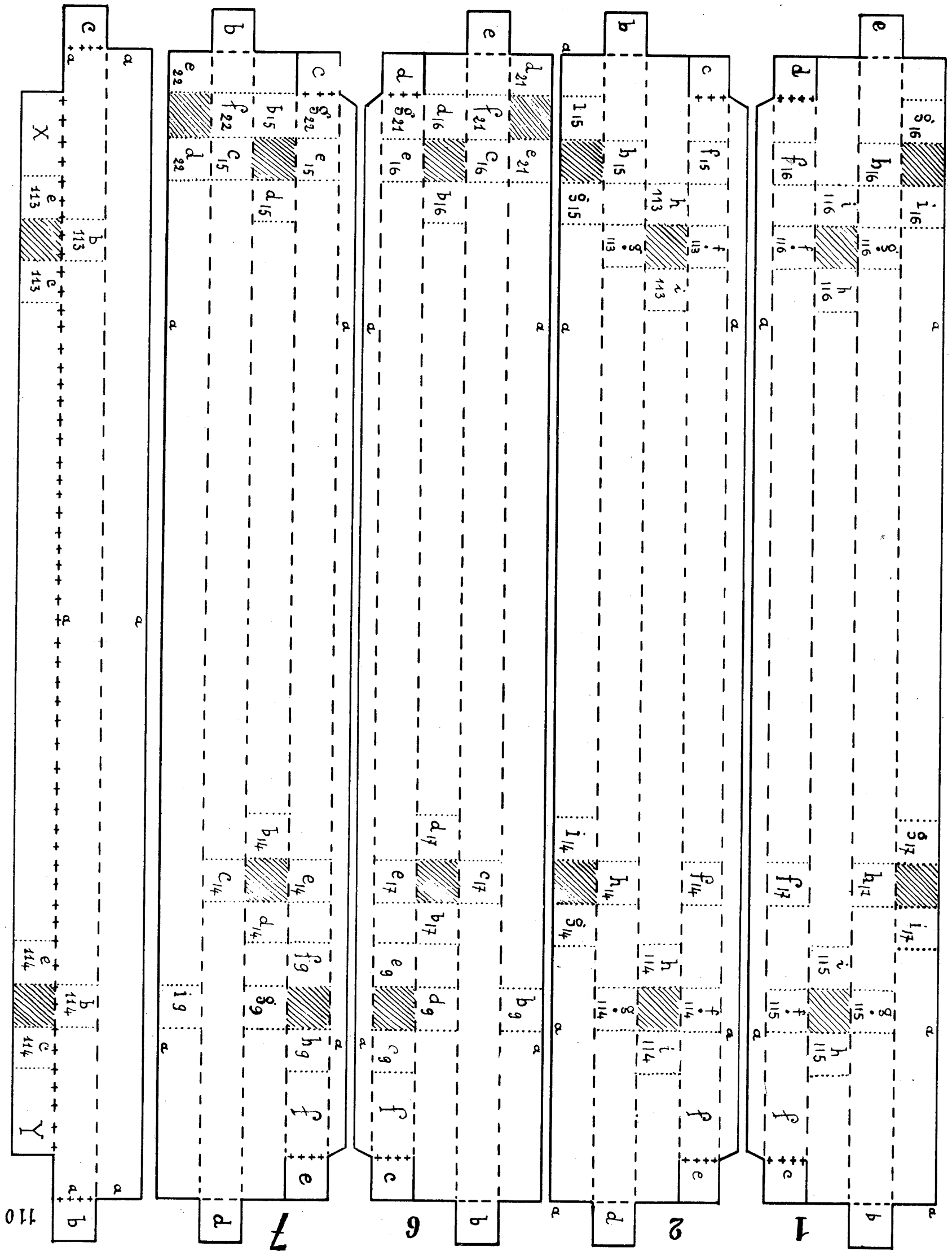

Metal wire going through the weight.



axle: wheel 81, 84
axle: motor wheel 50, 58
axle for the hands

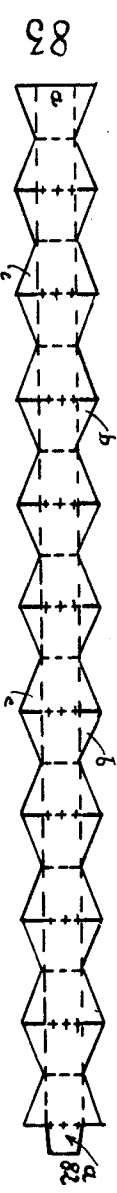
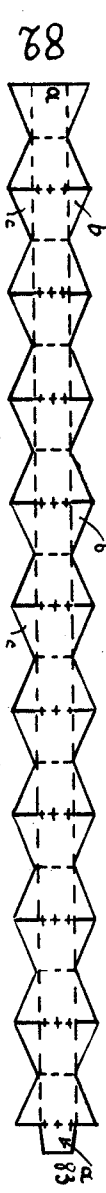
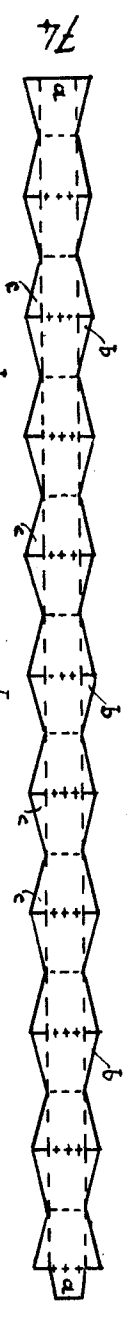
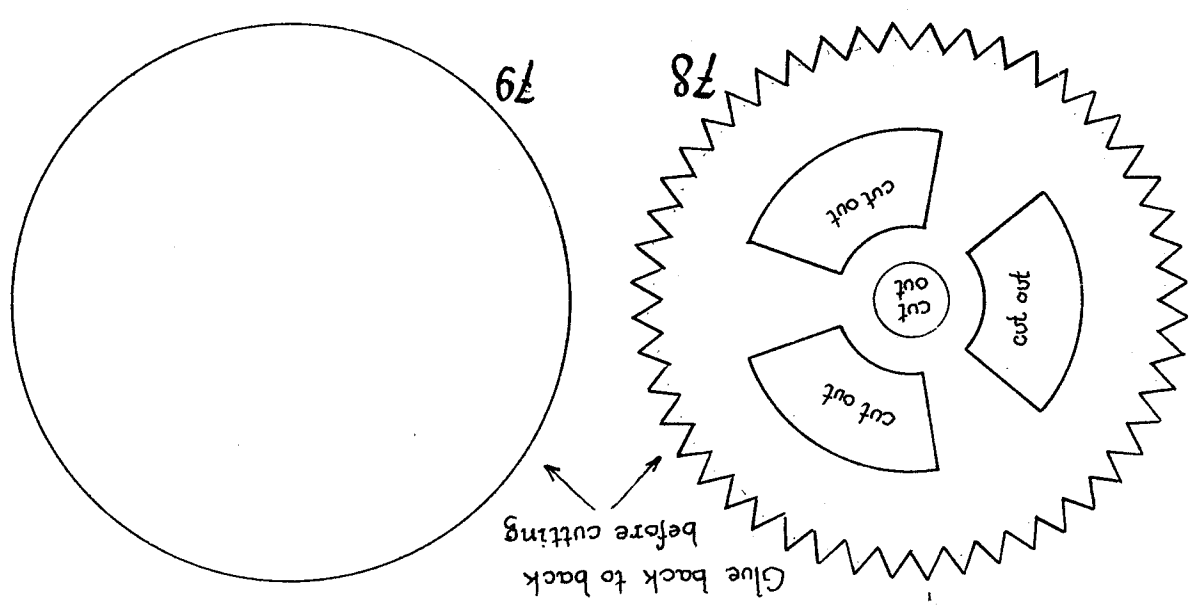
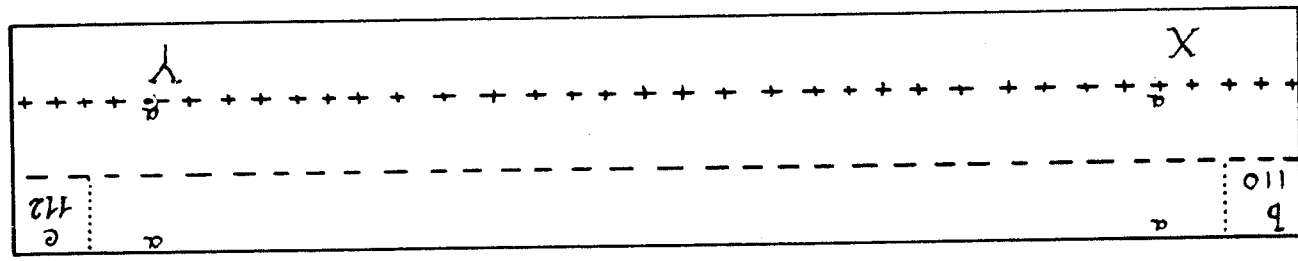
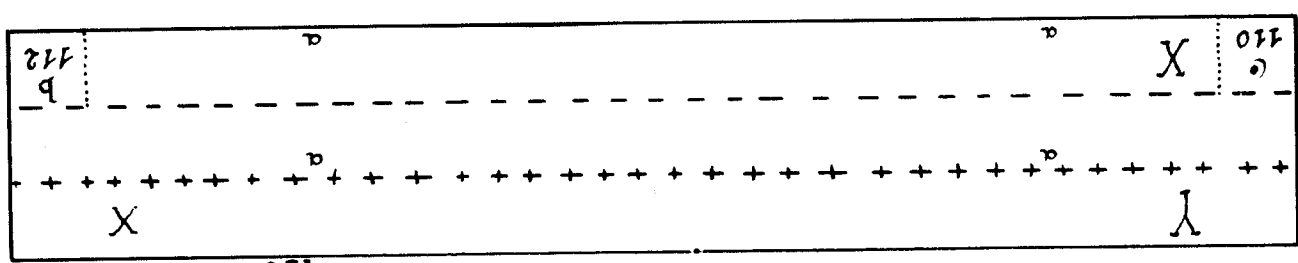
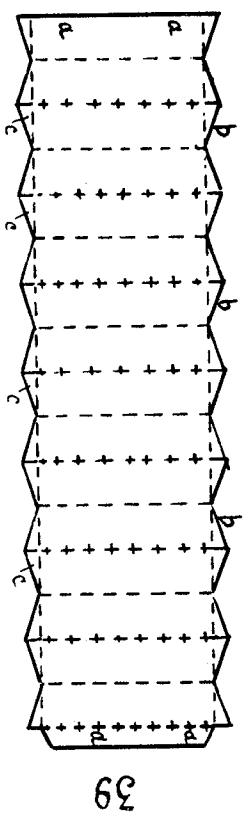
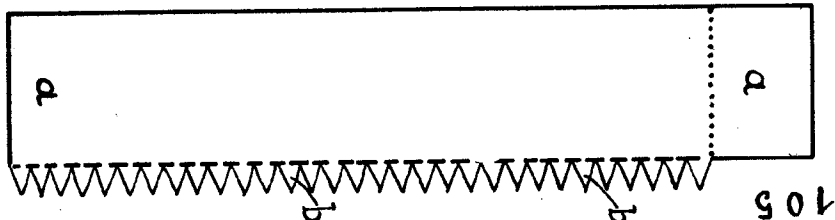
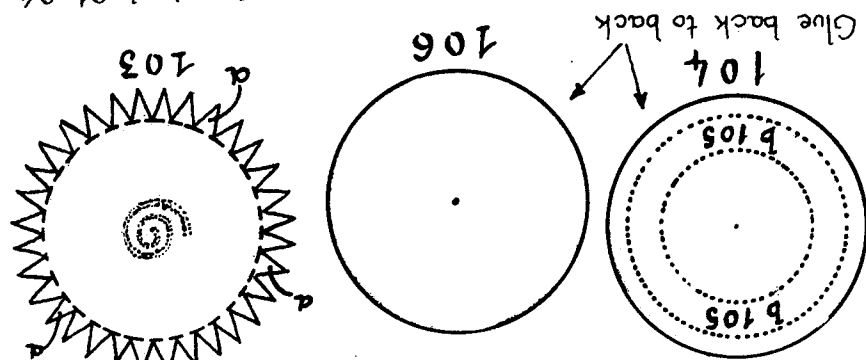
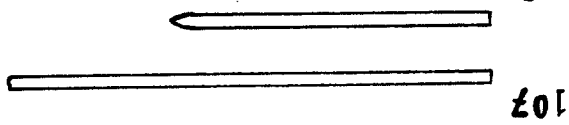

60

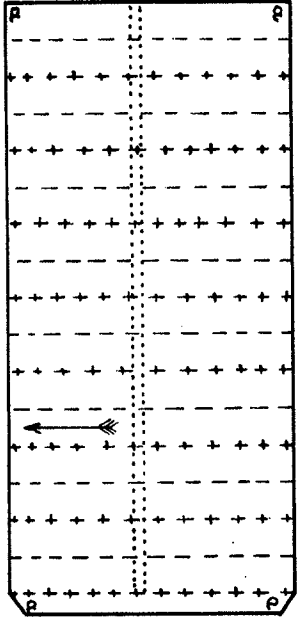

101

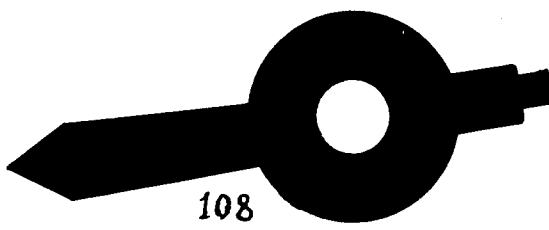
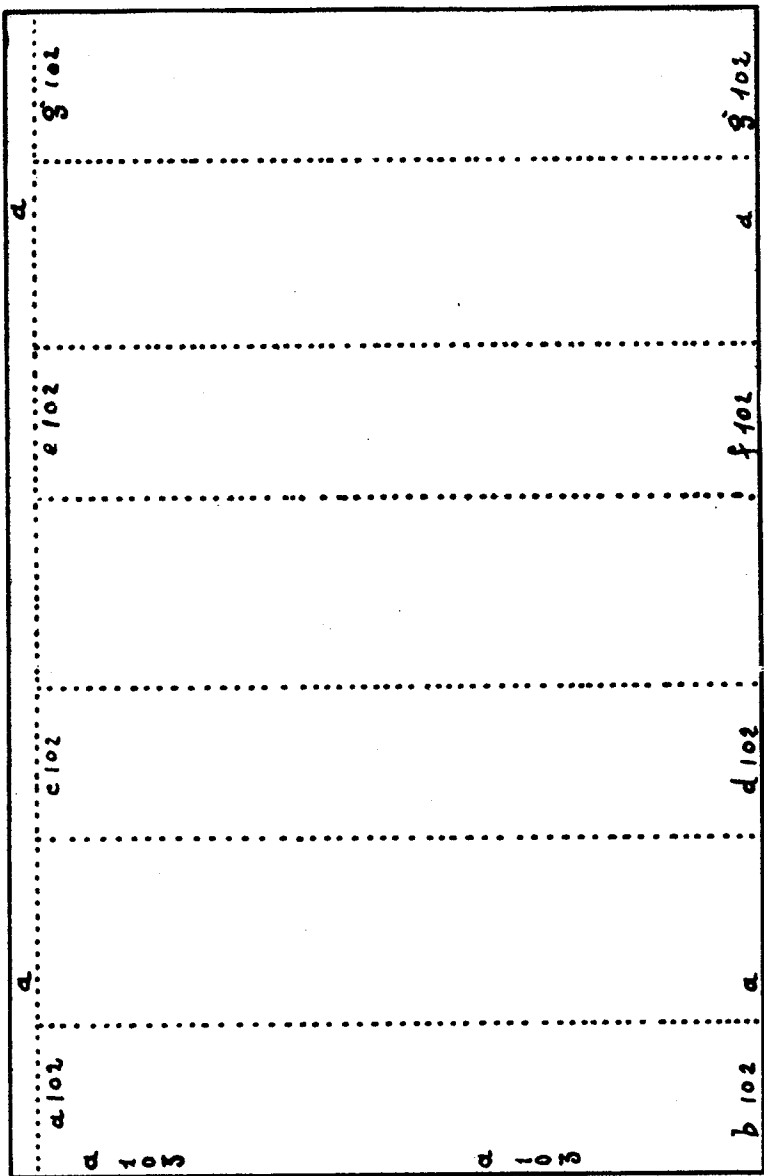

Glue on heavy cardboard.

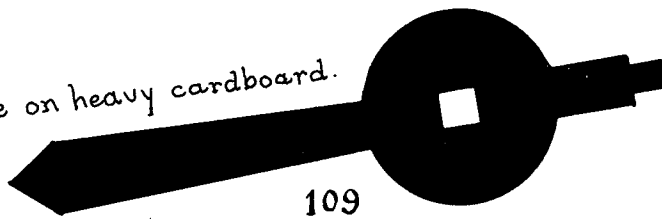

102

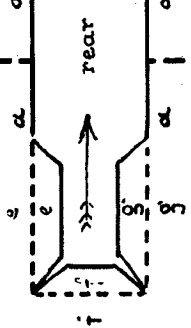
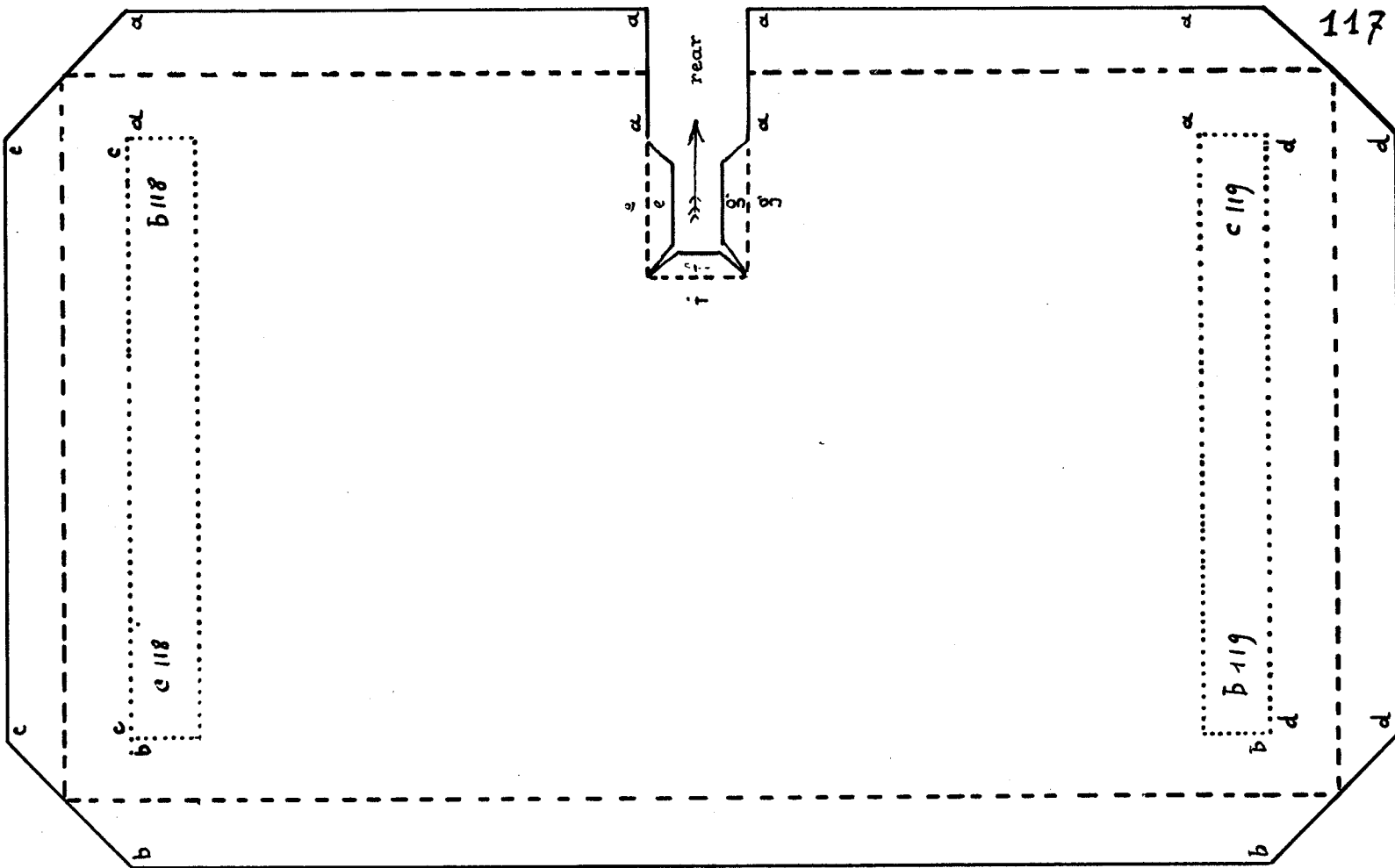
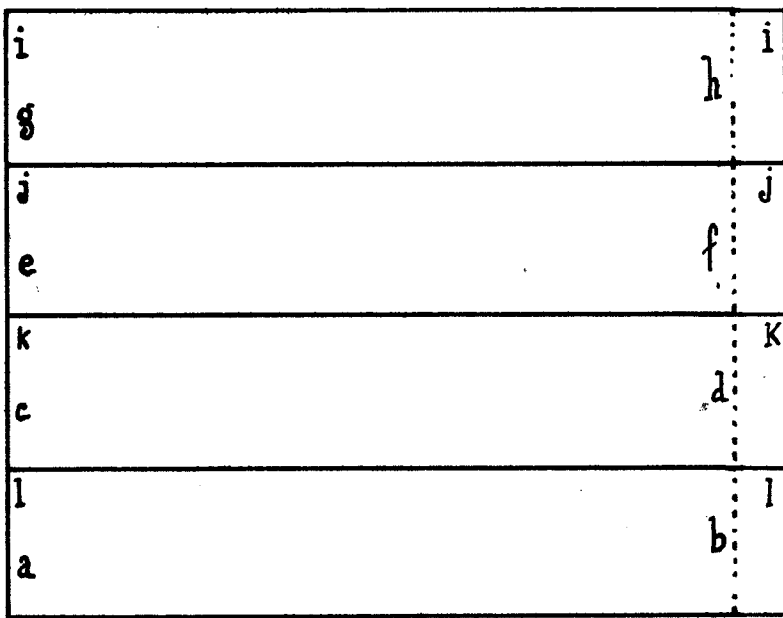

119

Glue to b119 and c119, but on the underside of piece 117

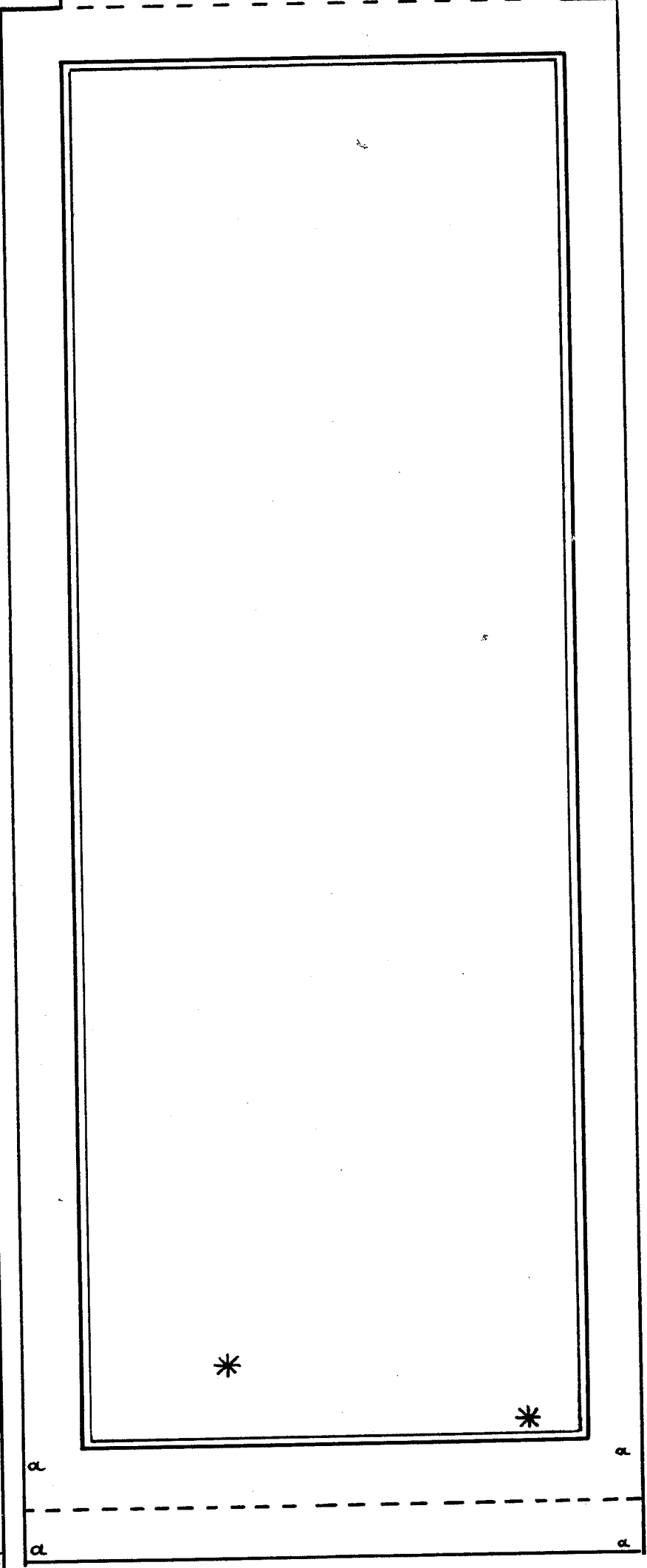

118

Glue to b118 and c118 but on the underside of piece 117

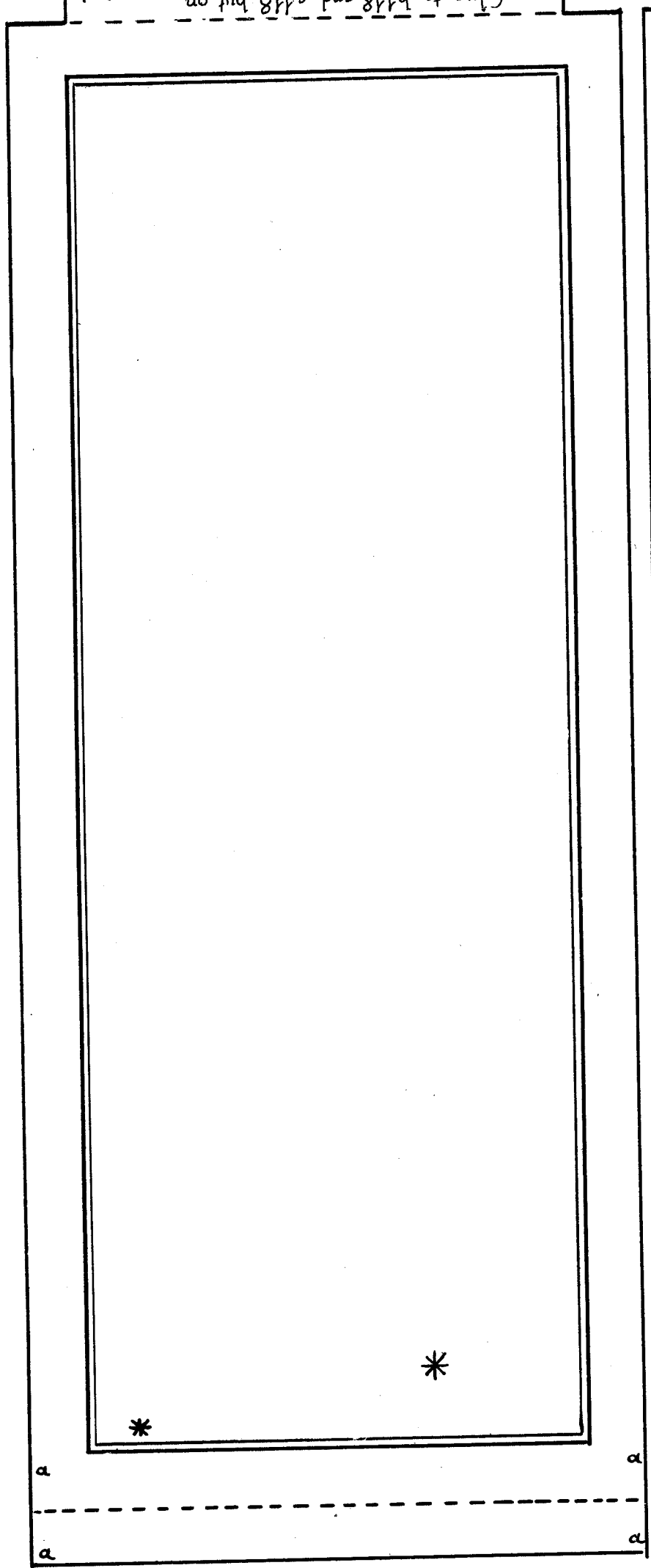

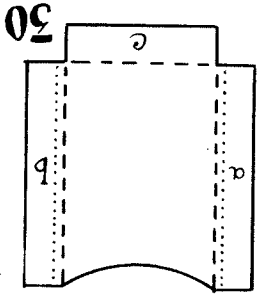
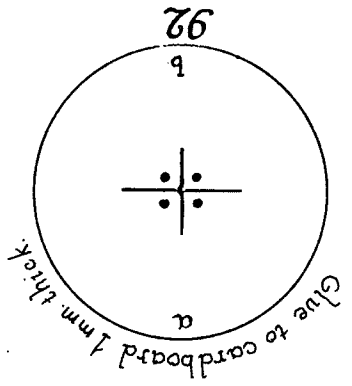
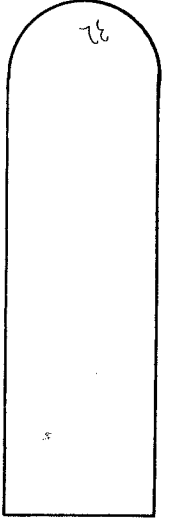
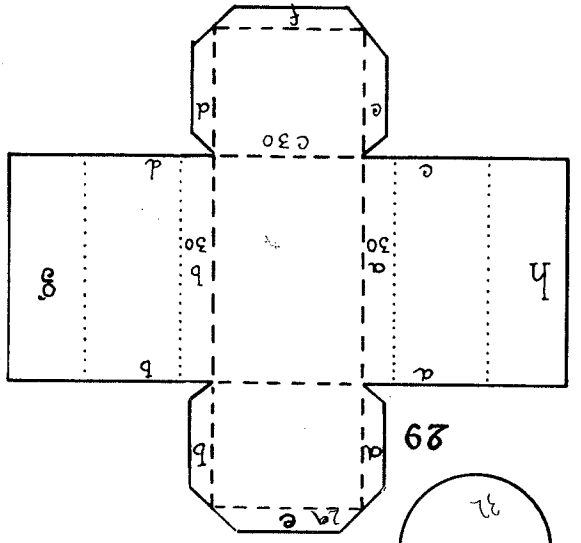

Glue piece 91 to cardboard 1mm thick

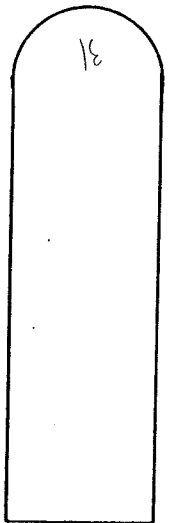
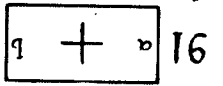

Glue back to back to 32.

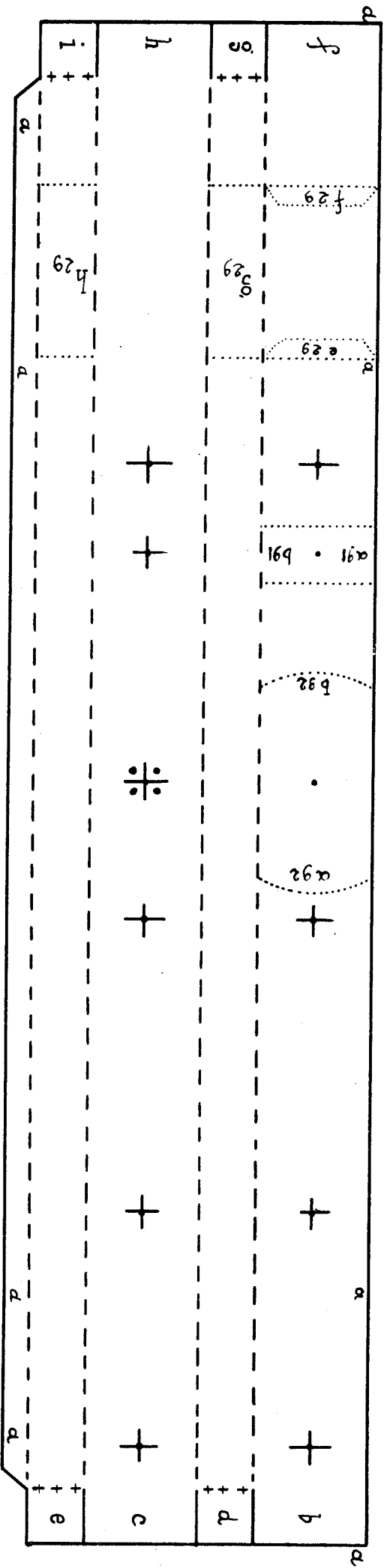
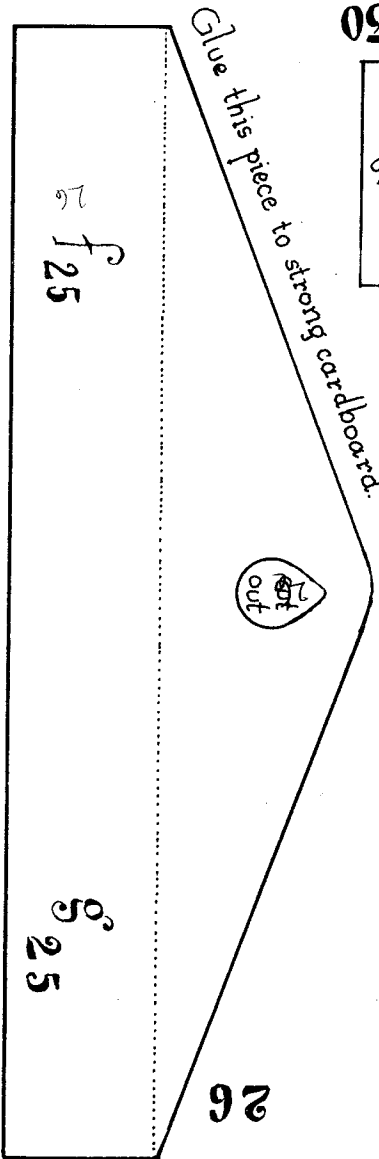

4

10

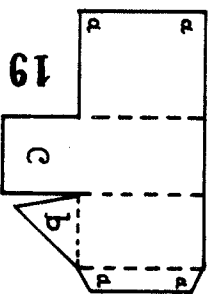
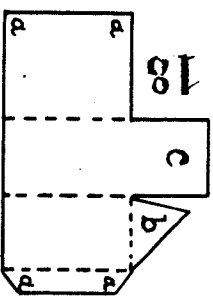
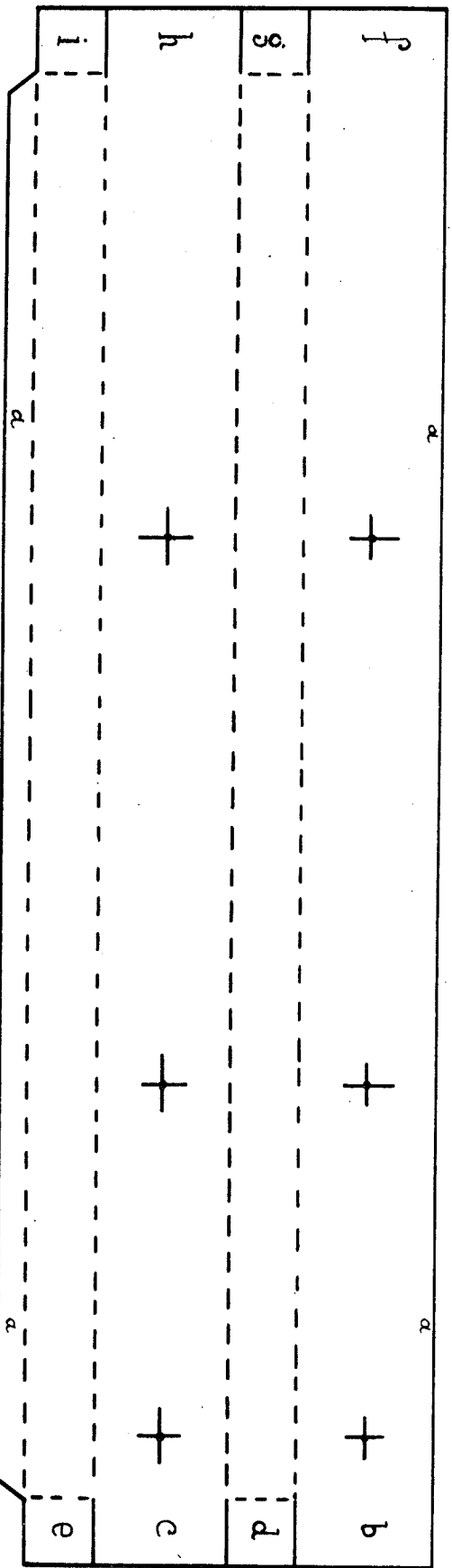

Glue 58 back to 59 before cutting.

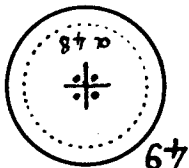
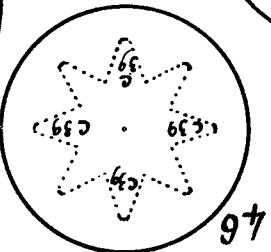
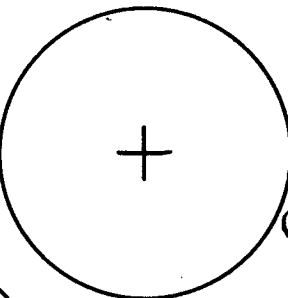
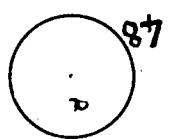
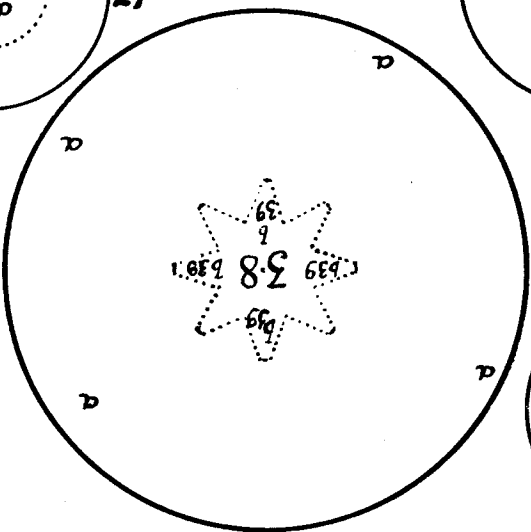
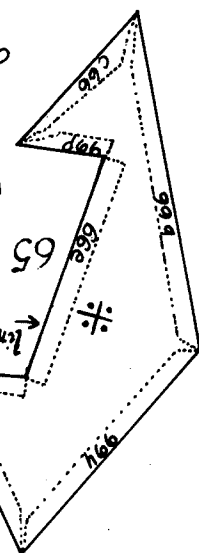
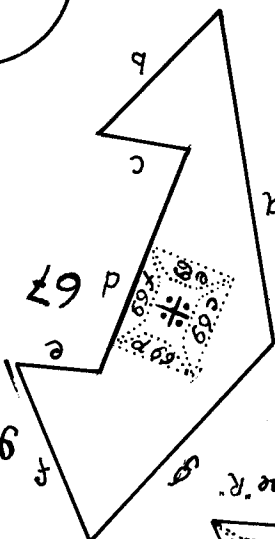
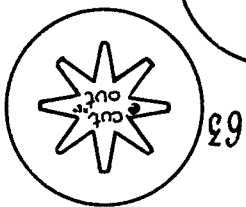
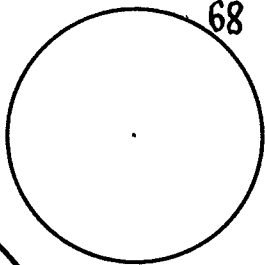
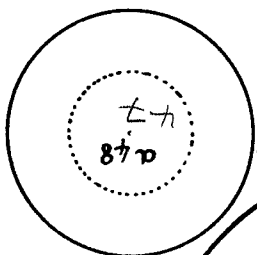
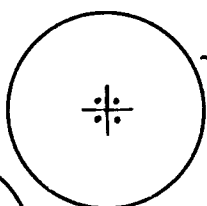
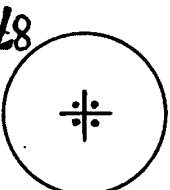
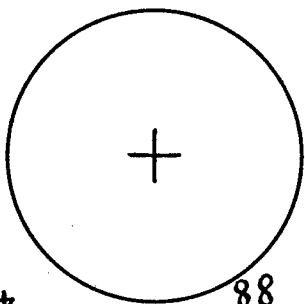
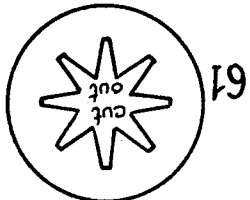
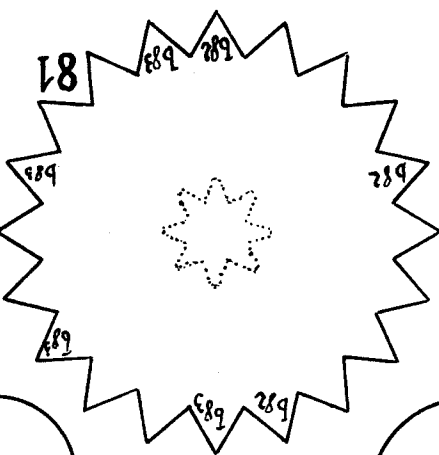
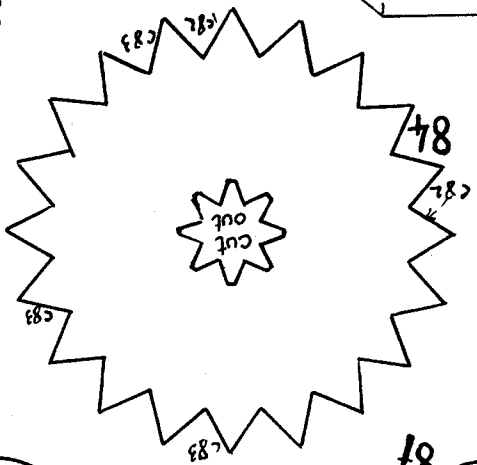
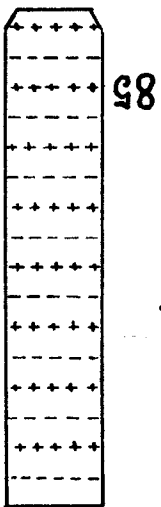
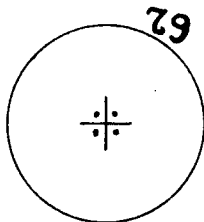
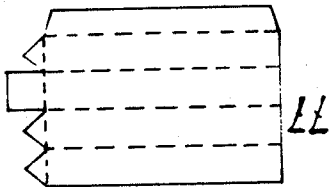
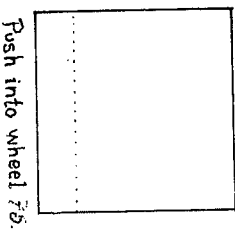
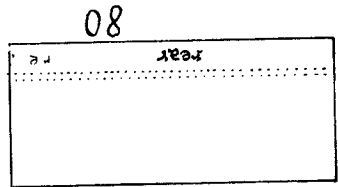
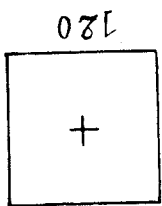
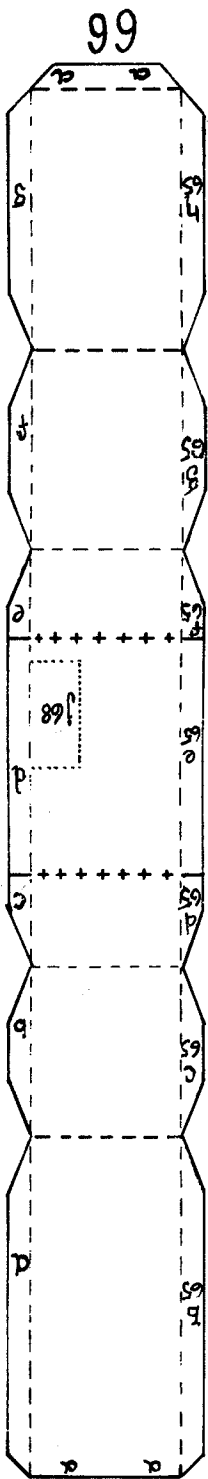
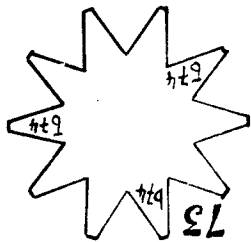
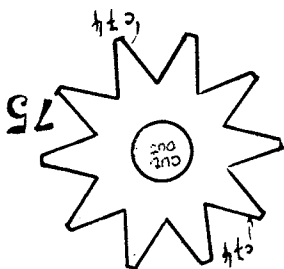
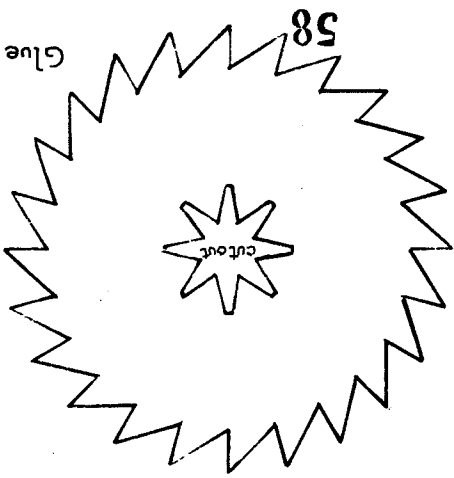
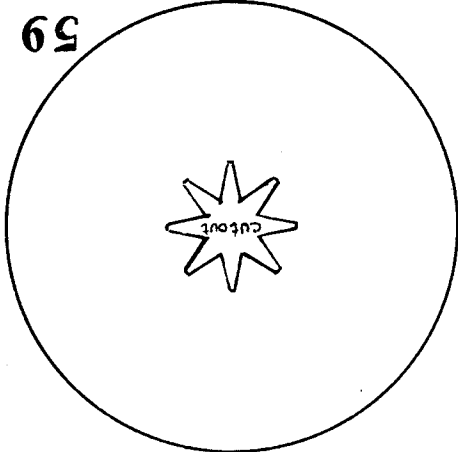

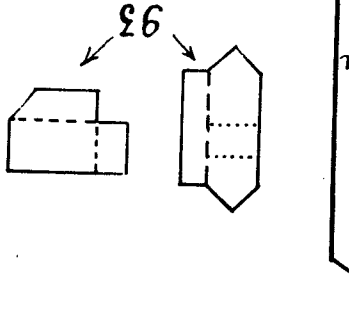
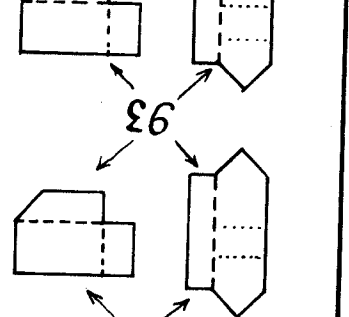
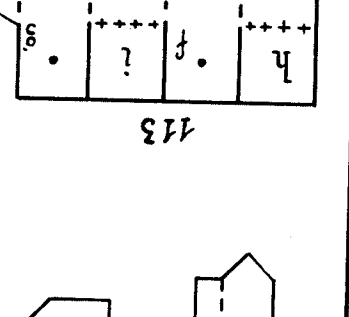
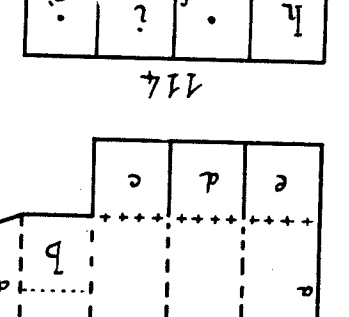
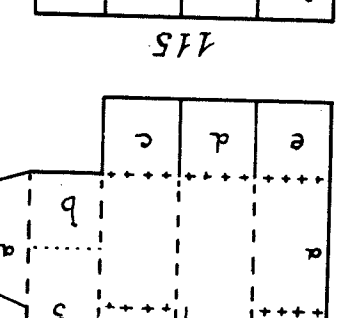
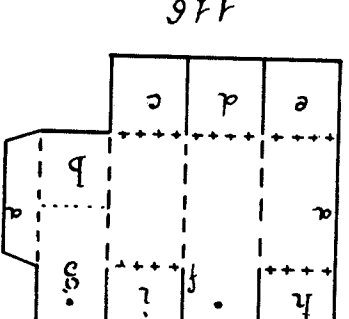
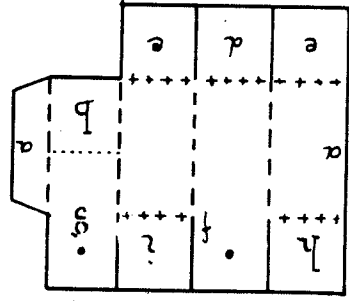
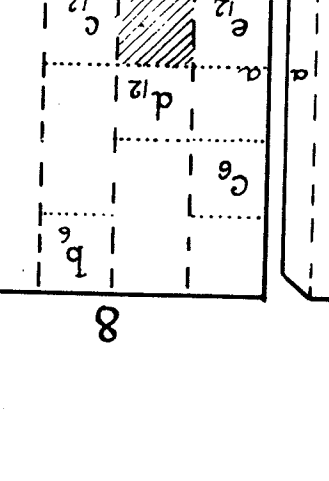
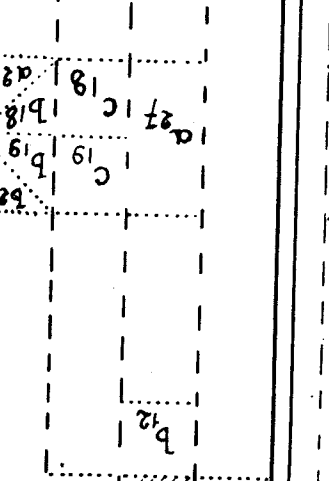
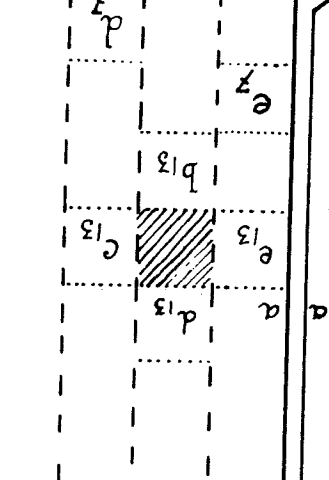
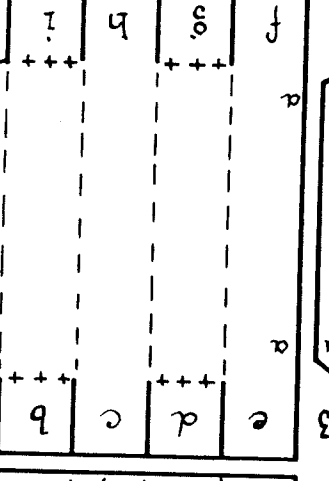
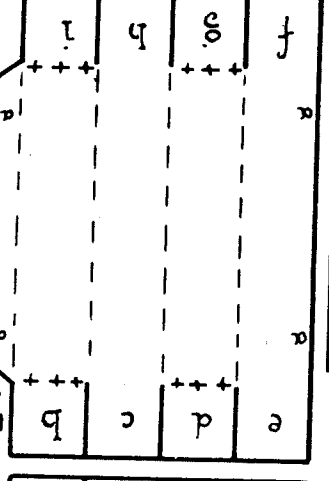
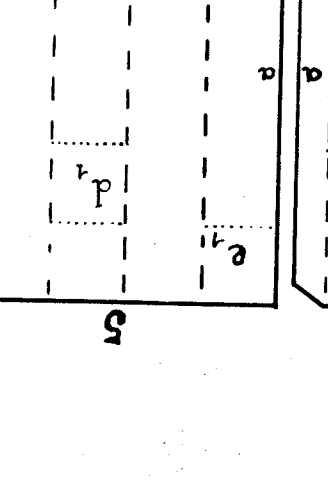
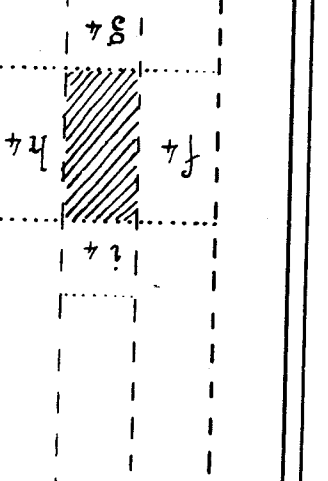
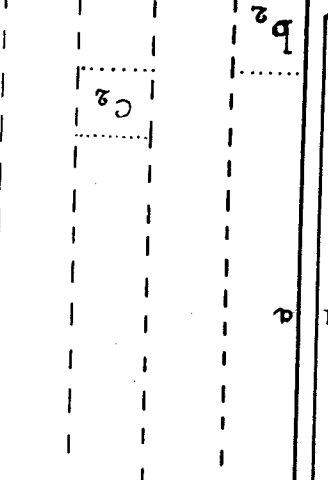
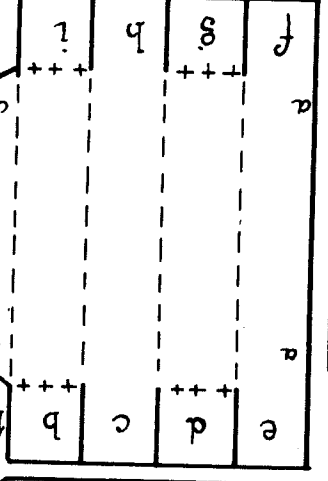
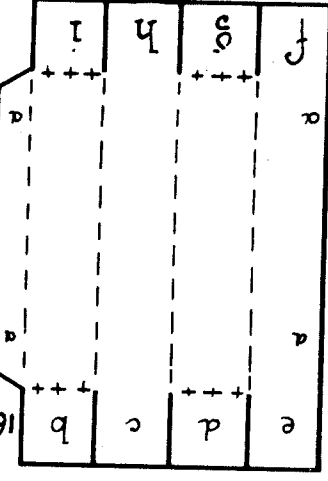
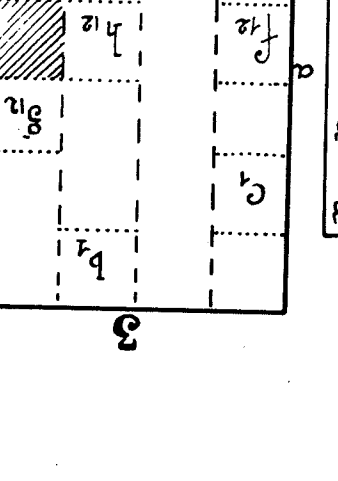
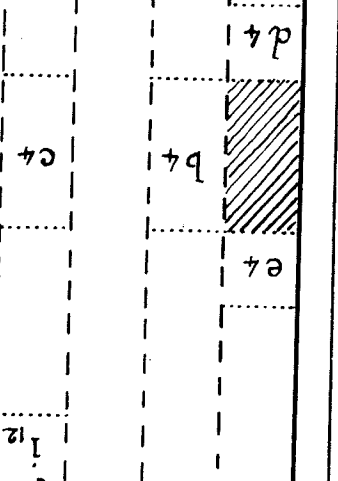
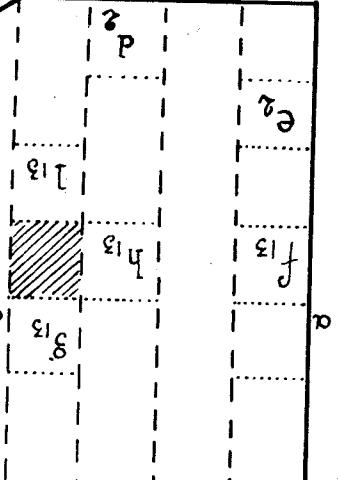
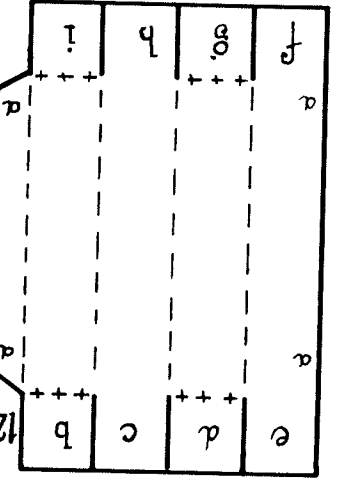
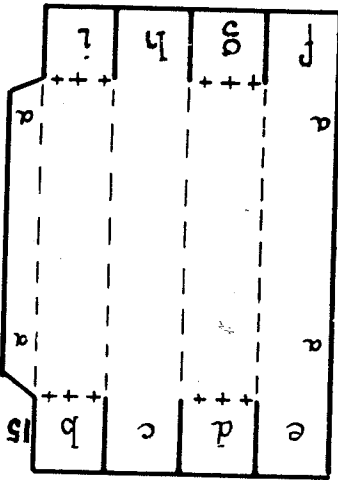
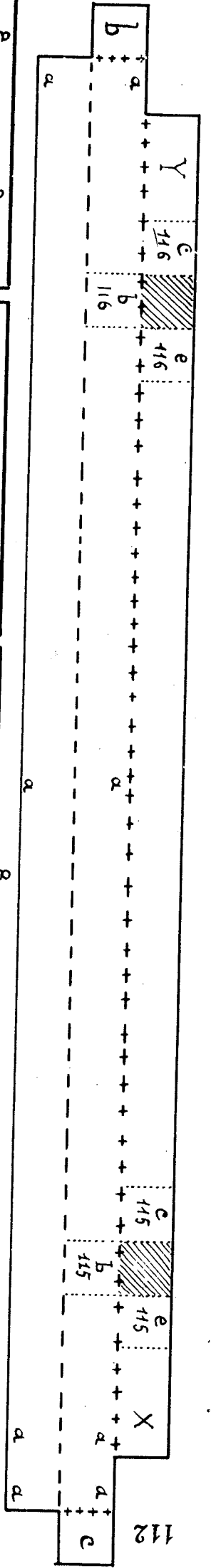

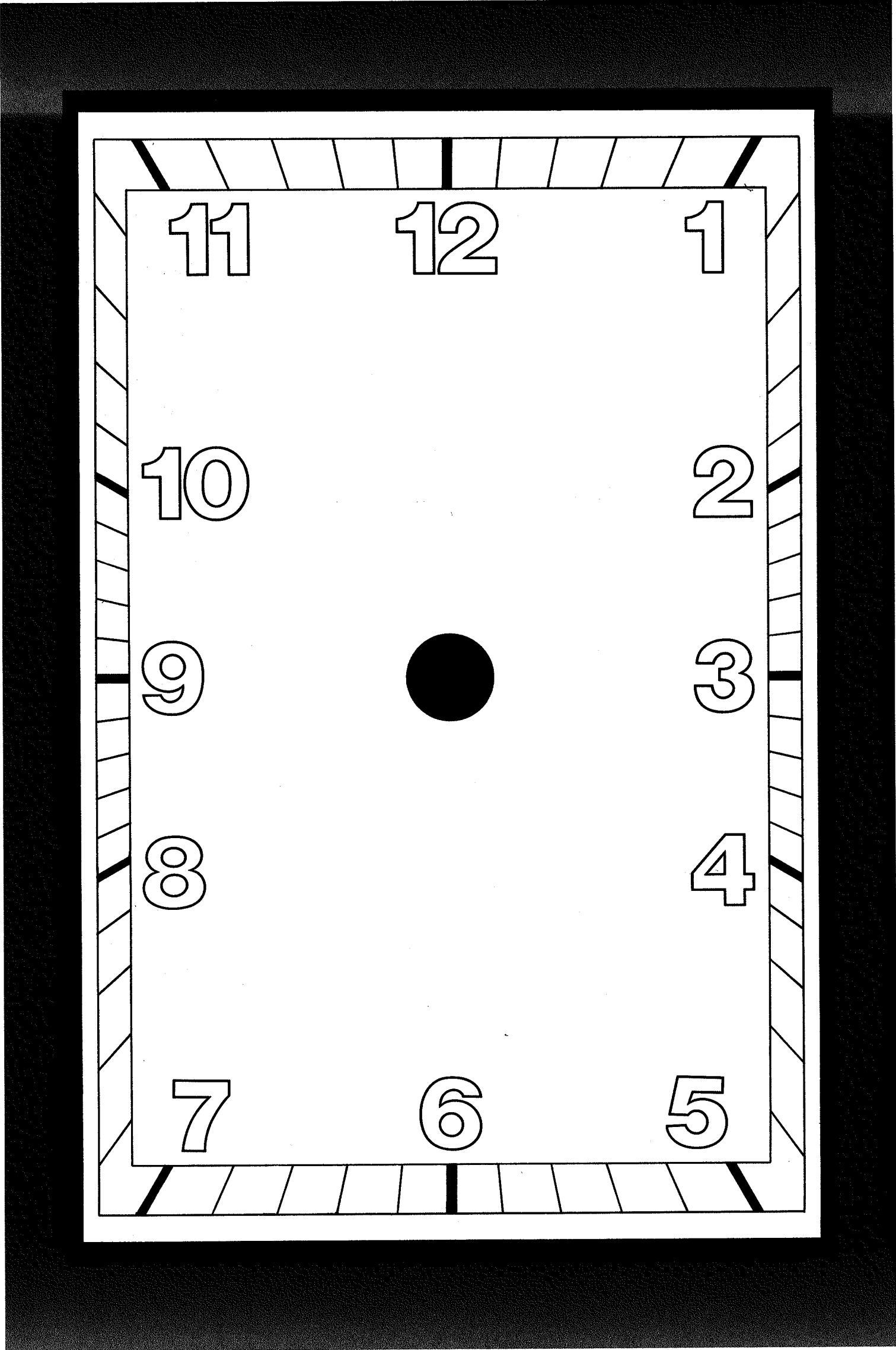

11

12

1

10

2

9

3

8

4

7

6

5

Instructions for Assembly

Cutting and assembly of this construction require great care and patience. Do not try to work too fast. Follow exactly the detailed instructions below and you will be rewarded with a paper clock that actually works and that will tell the time as precisely as your wristwatch.

I. GENERAL DIRECTIONS

A. Fitting and Identification of Pieces

Each piece or part of a piece is numbered. The sequence of these pieces will tell you the order in which the pieces should be cut out and assembled. The numbers of the pieces do not appear on the pieces themselves. Therefore, it is wise to write the correct number on each piece with a pencil before cutting the piece out, so that you can identify it when ready to assemble it. To make any individual piece, spaces on that piece bearing identical letters should be glued together. **Example:** On piece 18, the part marked "aa" should be glued, after folding, to the other part marked "aa" of piece 18.

Certain spaces on some pieces are labeled with a letter and a number. This means that the space with that letter on the piece with that number should be glued there. **Example:** On piece 3, the space marked "b4" should be covered by space "b" of piece 4, and glued together in that position. These rules should be followed without exception.

B. Cutting and Folding

With an X-acto knife (blade No. 11) and using a metal straight edge as a guide, cut all pieces on the solid lines. Broken lines (- - - -) indicate where you should fold away from yourself. In order to obtain an accurate fold, it is wise to score the line accurately and lightly with the dull side of your X-acto knife. Be careful not to cut through the paper. Lines indicated like this (+ + + + +) are those that you should fold toward yourself. These lines, as well, should be scored with the dull edge of your X-acto knife, but on the blank side of the sheet. To locate scoring lines on the blank side of the paper, make small pin holes on each end of the line.

C. Gluing

Use latex glue. Spread it thinly and avoid heavy build-ups. Let each piece dry thoroughly after it is glued.

D. Mounting of Pieces

Each piece or part of a piece should be folded, glued, and allowed to dry before it is attached to another piece. Assembly of the various pieces should be done in strict numerical order, and only when the different pieces of the element you are constructing have been folded and glued.

E. Axles

These can be made of pieces of wire or paper clips that have been carefully straightened. Be sure that they do not extend either to the rear, where they would impede the movement of the pendulum, or to the front, where they would interfere with the wheels of the hands. The axle of the motor wheel and the axle of the minute hand should be fashioned from a No. 1 U.S. knitting needle, or a similar needle of a diameter of 2 mm. In order to make a clock that keeps very accurate time, and in order to avoid wear at the axle points, bearings can be fashioned from glass, wood, or plastic beads. These beads should be glued in or wedged in at the points marked +. These bearings should not permit excessive play of the axles, but even more important, they should not squeeze the axles. It is essential that the bearings be placed in the exact center of the moving parts. The axle holes marked + do not require a bearing. These axles stationary at these points.

II. CONSTRUCTION

Carefully remove the staples from the book and flatten out all the pages that have cut-out pieces printed on them. The assembly of the following five elements of the clock should be made in the strict numerical order of the components.

- A. The framework and the wall bracket
- B. The mechanism, composed of three wheels and the weight
- C. The anchor and the pendulum
- D. Mechanism of the hands
- E. The weight
- F. The face and the case

A. The Framework

Fig. 1. Frame assembly: pieces 1 to 22, inclusive (pieces 29, 30, and 31 are shown for convenience).

Fig. 2. Detail of the pendulum support, showing supporting bracket for rear end of escapement axle: pieces 18, 19, 27, and 28 (piece 27 not visible).

Fig. 3. Wall bracket: pieces 23, 24, 25, and 26.

Fig. 4. Assembly holding the hand wheels in place: pieces 29, 30, 31, and 32 (pieces 31 and 32 indicated by dotted lines).

Cut, glue, and assemble following the general directions above. Piece 3 hangs from the forward arms of the wall bracket (Fig. 3). Pieces 31 and 32 are to be glued back to back and then inserted *without* glue into the slot between pieces 29 and 30 (Fig. 4). The mechanism is assembled in place after the entire framework is glued together.

Locate pieces 27, 28, 33, 47, 48, 49, 50, 51, 57, 62, 64, 65, 67, 69, 87, 88, 89, 90, 91, 92, 104, 106, and 120 and make a small pin hole in the center of each as indicated, so that you can locate the exact center on the reverse side and insert the axles later.

B. The Mechanism

1. Motor wheel: pieces 33 to 49, inclusive
2. Middle wheel: pieces 50 to 57, inclusive
3. Escapement wheel: pieces 58 to 64, inclusive

1. Motor Wheel

Fig. 5. Detail of the motor wheel

Fig. 6. Position of the strip forming the teeth, piece 37

Fig. 7. Pulley, illustrating the means of rewinding the clock

When cutting out pieces 33 and 36, cut around the perimeters first and then remove the excess paper between the teeth. The tabs of pieces 33 and 36 should be lined up so that pairs of teeth are directly opposite each other, thereby permitting each tooth from piece 37 to be extended from one tab to its corresponding member on the other piece. Mounting these strips gives the necessary rigidity to the teeth. They must be placed with precision, so as not to throw the wheel out of alignment. To avoid warpage, at each stage of gluing together the pieces of the motor wheel, weight the pieces down with a rigid book while the glue dries.

Following carefully in numerical order, construct the pulley. Cut out and fold the accordion-shaped piece 39, glue it closed, and then glue the entire piece as indicated to piece 38. Glue the ends of piece 40 together, apply glue to the inside of the resulting cylinder, and slip it over piece 39, with the arrow of piece 40 pointing toward the motor wheel. Glue the marked end of piece 41 to piece 40, being certain that the "a" and "b" of one correspond to the "a" and "b" of the other. Then roll the end of piece 41 around the cylinder *without* gluing it and cover it with piece 42, which forms the drum of the pulley. The arrow on piece 42 should point toward the motor wheel. The pulley will then work independently of the motor wheel in a clockwise direction, permitting rewinding of the clock. In the other direction, piece 41 will catch between

the two drums and will thus drive the motor wheel. Next, form the throat of the pulley by gluing pieces 43 and 44 as shown in Fig. 13. Wrap piece 45 around the cylinder between pieces 43 and 44, and glue in place. Finish the pulley by gluing pieces 46 and 47 back to back and then attaching them to the exposed end of piece 39. **Caution:** When gluing pieces 46 and 47 to piece 39, keep glue away from piece 42. Piece 42 must be able to turn freely. Next, glue piece 48 to a double thickness of cardboard, attach it to the end of the pulley, and cover it with the plate, piece 49. Finally, glue piece 38 to the motor wheel, piece 36, as indicated.

2. Middle Wheel

Fig. 8 shows the details of the assembly.

Glue pieces 50 and 51 back to back. Following the lines for the teeth on piece 50, cut through both pieces. Glue piece 52 to 51. Glue pieces 53 and 54 back to back and remove the center section as indicated. Glue piece 53 to 52. After spreading glue on the edges of the star-shaped hole in piece 54 and on the edges of one end of the pinion, piece 55, push the pinion into the star-shaped hole in piece 54, and up against the wheel, piece 51. Remove the center part of piece 56 and slip it over the pinion. Insert a wire through the center of piece 50 and place it flat on the table. Apply glue to the end of the pinion and to the top of piece 56. Slip piece 57 on the wire, press it against the pinion, and lift piece 56 against 57. Before the glue dries, spin the element on the wire to make sure it turns without eccentricity. Adjust piece 57 before the glue dries to correct any wobble.

3. Escapement Wheel

Glue pieces 58 and 59 back to back before cutting the teeth and the center hole. Form the pinion with piece 60. Hold the pinion with its arrow pointing away from you. Push the pinion through the star-shaped hole in piece 58, until 58 is exactly between the dotted lines on piece 60, and the teeth on the wheel point in the direction shown in Fig. 11. The wheel should be placed perfectly perpendicular to the pinion. On the end of the pinion place pieces 61, 62, 63, and 64 in the same manner that you used on the middle wheel.

4. Mounting the Wheels

See the drawing of pieces 107 for the dimensions of the axles.

Except for the axles of the minute hand and the motor wheel, cut axles from wire or carefully straightened paper clips. The beads must turn freely on the axles, and the wheels must not be warped. First, pass the axle of the middle wheel through the holes of the frame and turn the wheel gently to make sure the wheel turns true. Then pass the axle of the motor wheel (the knitting needle) through the holes in the frame, and check to be sure the teeth of the motor wheel engage the pinion of the middle wheel. If the pieces of the wheels have been cut accurately, the gears will mesh without further adjustment. If the gears mesh too tightly or too loosely, enlarge the axle holes in the frame slightly. Cut cardboard squares like piece 120, shown as a model. Pierce the center of the square with the axle, and after spreading glue on

one side of the square, position it on piece 4 or piece 10 in the appropriate place. Before the glue dries, raise or lower the axle until the gears mesh properly and the wheels turn without resistance. It is better if the gears mesh a little too loosely rather than too tightly. *Don't turn the wheels fast.*

C. The Anchor and the Pendulum

See Fig. 9.

Assemble the anchor, pieces 65, 66, 67, 68, and 69.

The fork, piece 68, passes over the beam, piece 9, of the frame and will swing between the wall and the frame. The blade, piece 72, from which the pendulum hangs, is held in place by a horizontal pin passing through the hole drawn on the blade, and resting on top of pieces 18 and 19 on the back of the frame. Pieces 18 and 19 should pinch the blade between themselves. Squeeze the lower end of the blade into the slot on the upper end of the pendulum rod, piece 70, and glue securely. The pendulum rod passes through the end of the fork, piece 68. It must fit between the prongs of the fork without binding. If it binds, widen the gap in the fork with your X-acto knife. To the bottom of the pendulum rod, glue the square ring, piece 71, which will receive the pendulum hook. Put enough beads on the anchor axle, on both sides of the anchor, to prevent the fork, piece 68, from binding against the frame as it swings. Put beads on pieces 65 and 69, only. The axle hole in piece 67 should be large enough to permit play.

Fig. 11 shows the correct relationship between the anchor and escapement wheel. With the clock upright and facing you, and holding the pendulum stationary, apply a slight pressure to turn the motor wheel counterclockwise. As in Fig. 11, point "a" of the anchor should engage tooth "d" no more than 1 to 1.5 mm. from the point of the tooth. Then verify the proper operation of the escapement by removing the pendulum and slowly moving the fork from side to side. One point of the escapement wheel should pass point "a" on the anchor every time the pendulum makes a complete circuit—from one side to the other and back again. If the escapement does not function properly, either raise or lower the axle of the anchor slightly, using the same process described earlier in the explanation of mounting the wheels.

Glue the six pieces designated 93 together to form *three separate* braces, which will establish and maintain the shape of piece 94 (see Fig. 10). After the glue has dried, glue these braces inside piece 94, one in the middle, one five inches above the middle, and one five inches below. After assembling pieces 94 and 95, glue piece 95 to piece 94. Piece 98 should be bowed when glued onto piece 97, so it will hold the pendulum bob in place on the pendulum rod, piece 94.

D. Mechanism of the Hands

Pieces 73 to 92a.

Assemble pieces 73, 74, 75, and 76 to produce the wheel of the minute hand. Make a cylinder of piece 76, and glue it so that it fits into the hole in the wheel. Push the cylinder into piece 75 up to the dotted line and glue it in place. Glue piece 77 together. Fill piece 77 through half its length with a single piece of cork shaped with your X-acto knife. Push piece 77 into piece 76. Piece 77 will extend forward from piece 76 and hold the minute hand. Glue pieces 78 and 79 back to back. After the glue dries, cut out the teeth. Form another tube with piece 80 and glue it together, so that it will turn freely around tube 77. Insert tube 80 into the wheel of the hour hand, piece 78, up to the dotted lines. Tube 80 will hold the hour hand, piece 108. Assemble the reduction gear, pieces 81, 82, 83, 84, 85, 86, and 87. Glue piece 89 and two pieces of cardboard the same size between pieces 88 and 90. This makes the pulley for the hand mechanism. Pulley 48 on the front end of the motor wheel pinion turns pulley 89 with a crossed rubber band. Pieces 91 and 92 separate piece 4, the front center column, from the minute hand wheel and the reduction gear. Glue pieces 91 and 92 in place. Glue piece 92a on top of pieces 92 and 91, so that the axle holes coincide, and with the narrow end of piece 92a up. Mount the minute hand wheel, the hour hand wheel, and the reduction gear onto the frame as shown in Figs. 12 and 13. These three wheels are held in place by the tongue, piece 31, which is slipped into the slot between pieces 29 and 30, as shown in Figs. 1, 4, and 12. These wheels should move very freely when you rotate the minute hand in either direction. Mount pulley 89 onto the back end of the axle of the minute hand. Put the rubber band through the two pulleys 48 and 89.

E. The Weight

Form a tube from piece 101 and glue "a" to "a". Cut four strips from piece 102 and glue them around piece 101. Glue in the bottom, piece 103. Make the lid from pieces 104, 105, and 106. Bend a wire as shown in Fig. 107, and before making the hook, push it through the bottom of the cylinder, and then through the lid. Fill the cylinder with ten to twelve ounces of dry sand, lead shot, or nails. Tie two pieces of light string four feet long around the two throats of the pulleys of the motor wheel and glue them in place, as shown in Fig. 13. With the clock facing you, the back string should fall on the left side of the pulley and the front string should fall to the right. Wait for the glue to dry, then wrap the front string around the pulley in a clockwise direction. Tie a small object to the end of the front string to keep it taut. Attach the weight to the back string, which is still unwound. While supporting the weight in your left hand, pull the front string to wind the clock. Now set the hands to the correct time. Let the weight hang. Attach the pendulum to the pendulum rod with the hook facing the wall. Slip the bob onto the pendulum with the letters facing forward. Push the pendulum gently in one direction, and your clock will begin to run.

F. The Face and the Case

Assemble the frame, consisting of pieces 110, 111, 112, 112a, 113, 114, 115, and 116, and glue this frame in the exact center of the back of the face, as shown in Fig. 15. Then attach this assembly to the clock with four pins inserted through the dots shown on pieces 113 through 116.* The case is assembled from pieces 117, 118, and 119, then lowered onto the framework, and held in place with pins through the points marked "*" on pieces 118 and 119.

III. ADJUSTMENTS

Make sure the clock hangs on a vertical wall so that the clock is perfectly vertical. Otherwise the strings will jump their throats.

Make sure the two strings are wound properly in their respective throats of the pulley. The weight string should be in back, and the rewind string in front.

If your construction is perfect, the tick-tock sound will be regular when the clock is perfectly vertical. If the sound is not regular, move the clock slightly to right or left until it is, and leave the clock in that position.

The speed of the clock can be adjusted by sliding the bob. Raising the bob will speed up the clock; lowering the bob will slow it down.

* When you mount the face of the clock to its support, you might find that the glue you are using does not adhere well to the glossy back side of the face. If that be the case, transparent plastic tape can be used.



 Harper Perennial
A Division of HarperCollins Publishers

USA \$14.00
CANADA \$19.50

ISBN 0-06-091066-2



9 780060 910662

