

**INSTRUCTIONS:**

**STEP 1: Print.** Designed to fit on standard 8.5 x 11 inch paper and to be printed with any printer. A thick matte paper works best for extra sturdiness.

**STEP 2: Punch.** Using an awl or pen, lay the printed page on a soft surface (such as the carpet) and poke out the marked holes. It is easier to do it now than after the pieces are cut out.

**STEP 3: Cut.** Using your best pair of scissors and a steady hand, cut out all the limbs and shapes.

**STEP 4: Glue.** Fold the pieces along the designated fold lines and add a touch of glue to the white tab areas of each piece.

**STEP 5: String.** Cut some rubber bands (or wire or fishing line) and use them to string together the various limbs. Be sure to tie a knot on each end so it doesn't slip through the holes you punched earlier. A bent staple makes a great sewing needle for threading. See the next page for more detailed instructions of this step.

**STEP 6: Enjoy!** Now take a photo of your paper creation and send it to us at [PaperRobots1999.com](http://PaperRobots1999.com)!

Cut and assemble pieces as shown.

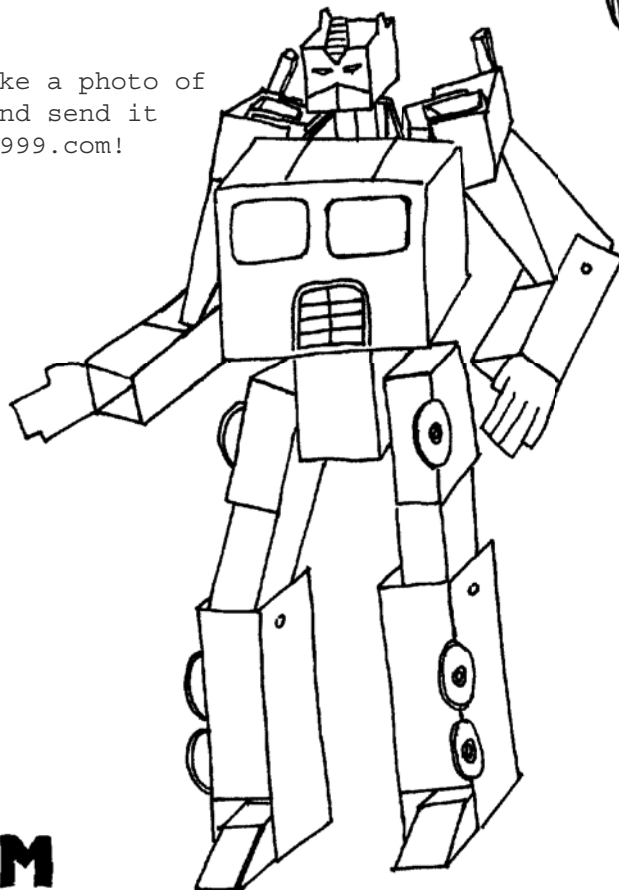
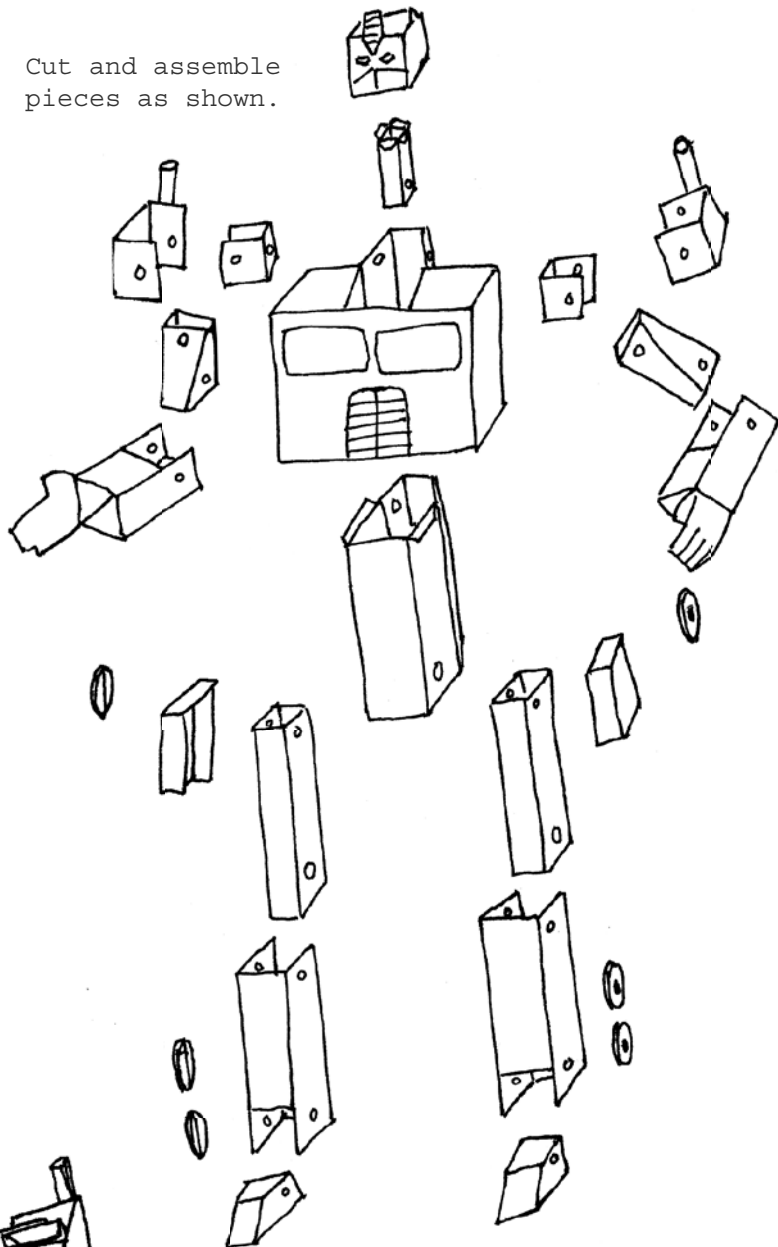

**PAPER  
ROBOTS  
1999.COM**

A.

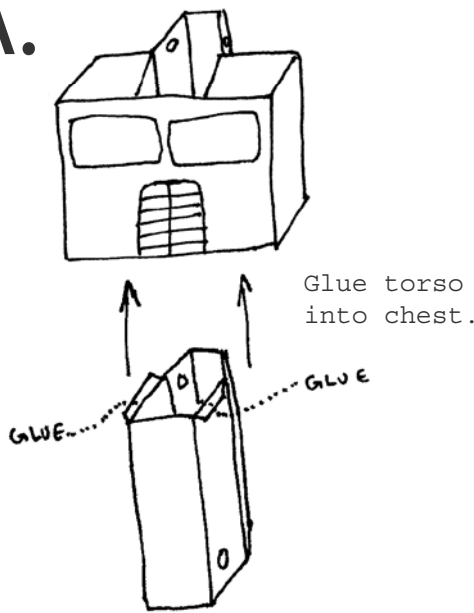

Glue torso into chest.

B.

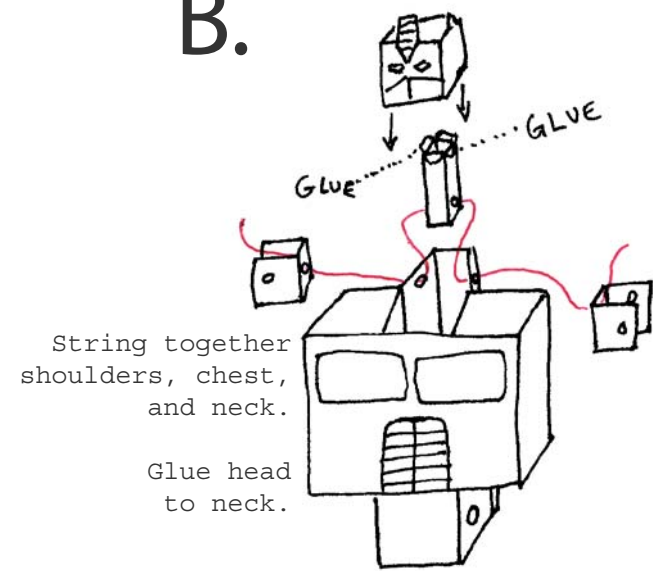

String together shoulders, chest, and neck.

Glue head to neck.

C.

String together upper legs, lower legs, and feet.

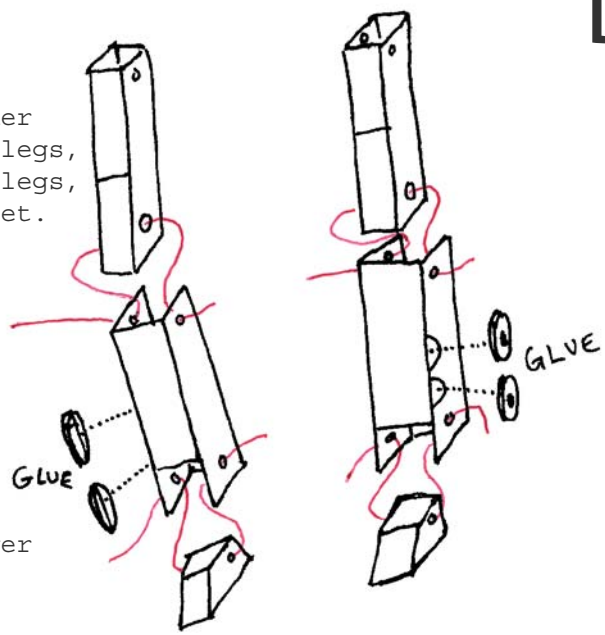

Glue wheels to lower legs.

D.

String together upper legs and torso.

Glue wheels to hips, and glue hips to upper legs.

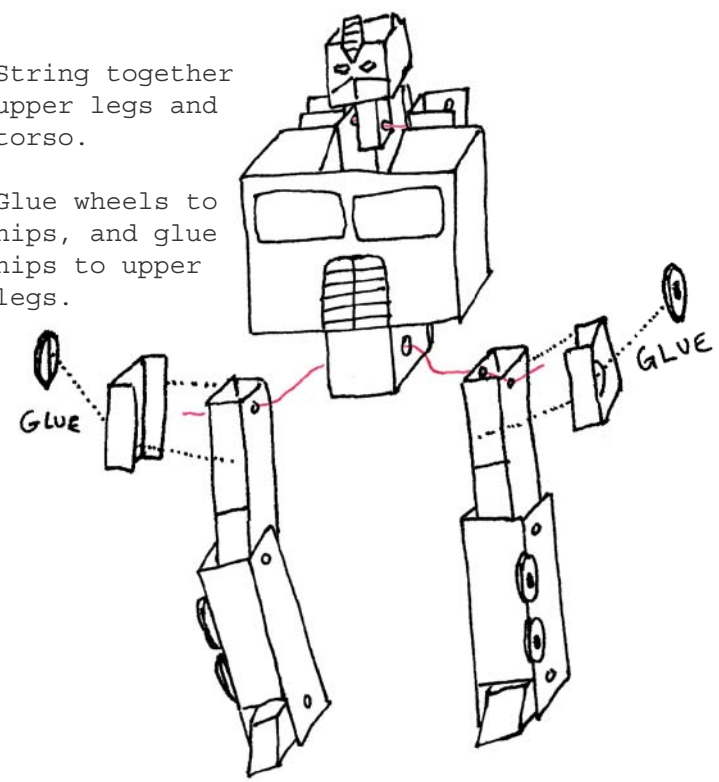

E.

String together upper arms and forearms.

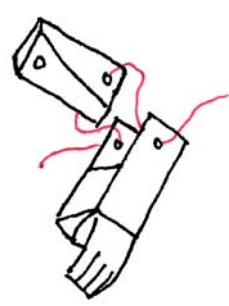

F.

Glue smokestacks to shoulder pads.

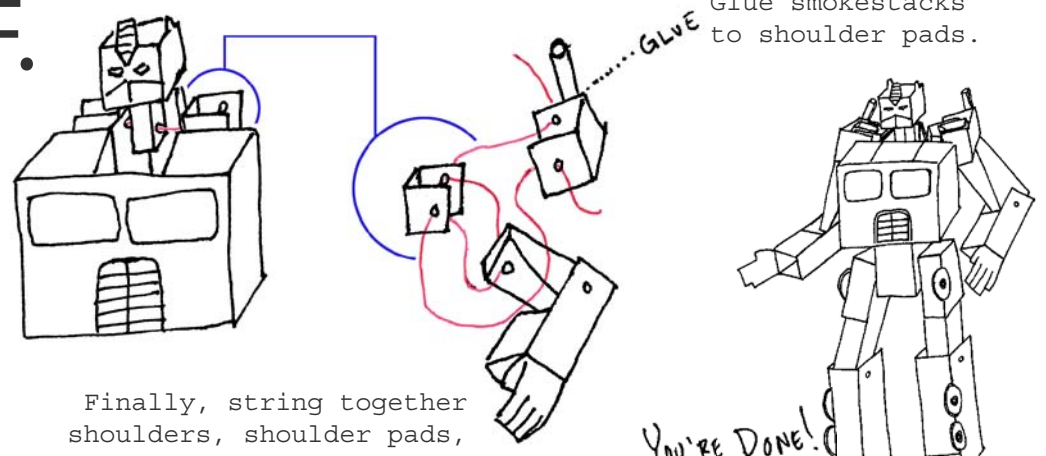

Finally, string together shoulders, shoulder pads, and upper arms.

YOU'RE DONE!  
HAVE FUN!